

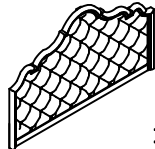

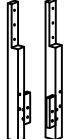

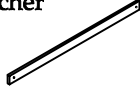



Hardware and Parts packed with the Headboard

Headboard Panel  (H-A) 1 pc.	Headboard Post  (H-B) 1 Right 1 Left	Headboard Stretcher  (H-C) 1 pc.		
Ø5/16" x 2" Allen Head Bolt  (H-D) 6 pcs.	Ø5/16" x 1-1/2" Allen Head Bolt  (H-E) 2 pcs.	Ø5/16" Spring Washer  (H-F) 8 pcs.	Ø5/16" x 19mm Flat Washer  (H-G) 8 pcs.	5mm Allen key  (H-H) 1 pc.

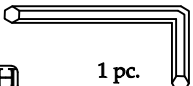
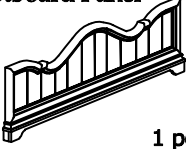
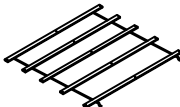
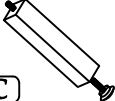
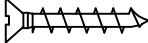
Hardware and Parts packed with the Footboard

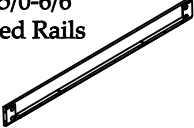
Footboard Panel  (F-A) 1 pc.	Wood Slat 60 3/4 long  (F-B) 5 pcs.	Support Leg 6 3/8 long w/leveler  (F-C) 5 pcs.	Ø8 x 1" Wood Screw  (F-D) 10 pcs.	
---	--	---	--	--

Hardware and Parts packed with the Bed Rails

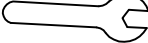
5/0-6/6 Bed Rails  (R-A) 2 pcs.				
Ø5/16" x 3-1/2" All-thread Bolt  (R-B) 8 pcs.	Ø5/16" Washer  (R-C) 8 pcs.	Ø5/16" Spring Washer  (R-D) 8 pcs.	Ø5/16" Hex Nut  (R-E) 8 pcs.	13mm Open Wrench  (R-F) 1 pc.

4/6-5/0 Queen Panel Bed

- 71676 -- 4/6-5/0 Panel Headboard
- 71671 -- 5/0 Panel Footboard & Slats.
- 71672 -- 5/0-6/6 Panel Bed Rails

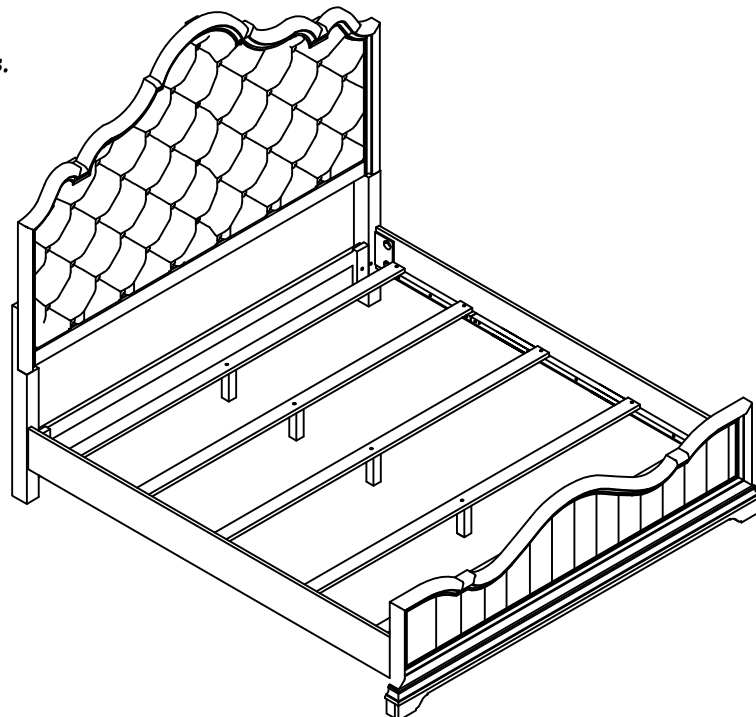

ASSEMBLY STEPS :

1. Place the Headboard Panel (H-A) face down on a clean and soft surface.
2. Attach the Left and Right Headboard Posts (H-B) to the back of the Headboard Panel, using the Flat Washers (H-G), Spring Washers (H-F) and Bolts (H-D). (see detail (A)). Do not fully tighten until after next step.

3. Attach the Headboard Stretcher (H-C) to the back of the Headboard Posts using the Bolts (H-E) and Washers as previous step. Tighten all Bolts using the Allen Wrench (H-H).(See Detail B).

4. Install the eight All-Thread Bolts (R-B) into the threaded metal inserts mounted on the Headboard and Footboard posts.

5. Gently lean the Headboard against the wall where the completed Bed will be located in the room.

6. Position one end of one Bed Rail (R-A) onto the All-Thread Bolts and fasten with the Washers (R-C & R-D) and Hex Nuts (R-E). Only partially tighten the Hex Nuts until the Footboard has been connected. Repeat for other Bed Rail.

7. Position and connect the Footboard to the other end of the Bed Rails as in previous Step.

8. Carefully align the Footboard to be 'square' with the Headboard. Using the Open Wrench (R-F) tighten all Hex Nuts attaching the Side Rails to the Headboard and Footboard. (See Detail C)

9. Attach the Support Leg (F-C) to the Wood Slat (F-B). (See Detail: D)

10. Attach the Wood Slats to the Bed Rails using the Wood Screws (F-D) and your Phillips Screwdriver. The levelers located at the bottom of the Support Legs can be adjusted if necessary. (See Detail E)

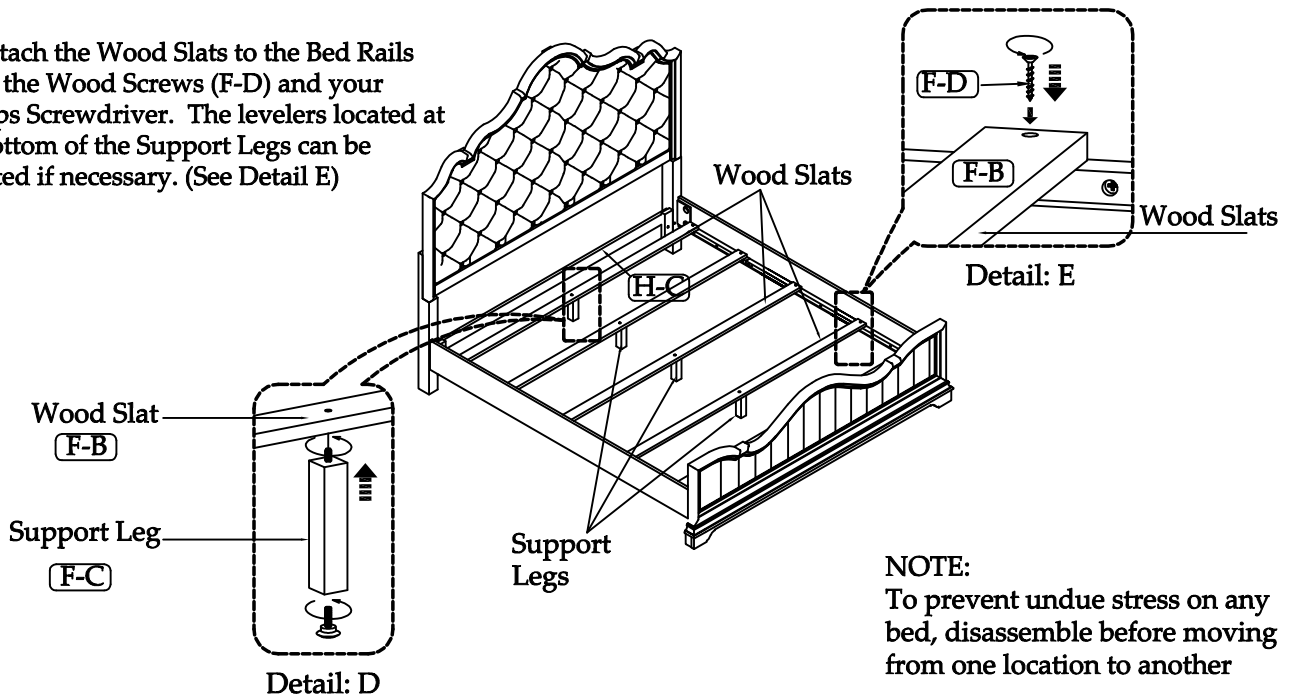
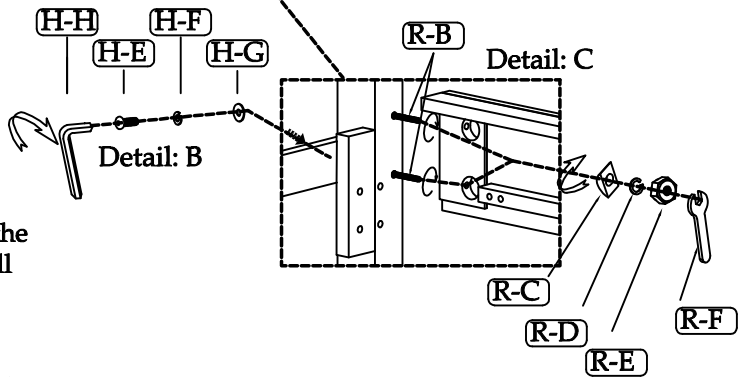
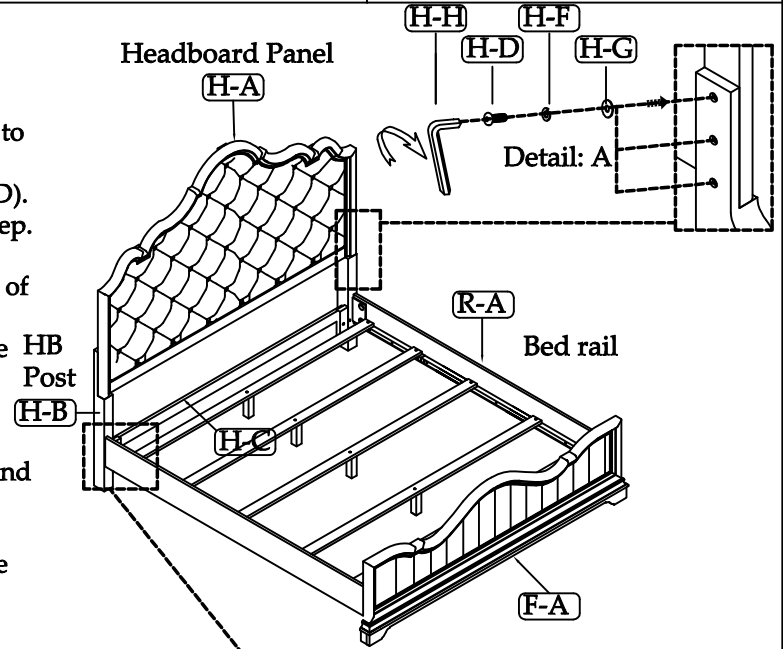

NOTE:
To prevent undue stress on any bed, disassemble before moving from one location to another

4/6-5/0 Queen Uph Arch Bed
71676 -- 4/6-5/0 Uph Arch Headboard
71671 -- 5/0 Panel Footboard & Slats
71672 -- 5/0-6/6 Panel Bed Rails

