

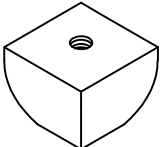

Components and Hardware List

 <p>Bun feet 4 pcs.</p>	 <p>Ø5/16"-18 x 2" All - Thread Bolt 4 pcs.</p>	 <p>Furniture Tipping Restraint Kit 1 pc.</p>
--	--	--

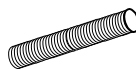

77828 Bunching Bookcase

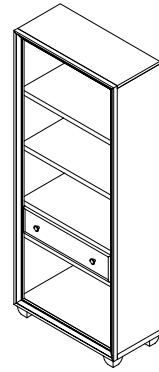
Be sure to check all packing material carefully for small parts, which may have come loose inside the carton during shipment.

For product and personal safety, a Furniture Tipping Restraint kit has been included with this unit which can help to minimize the risk of the unit accidentally tipping forward, if used and properly installed per the kit manufacturer's instructions.

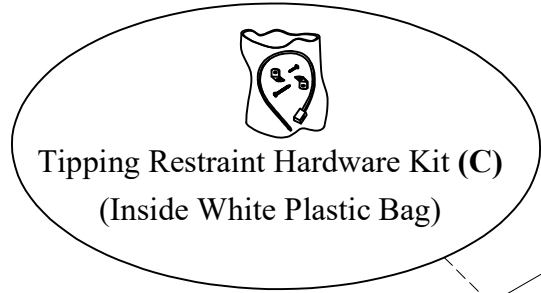
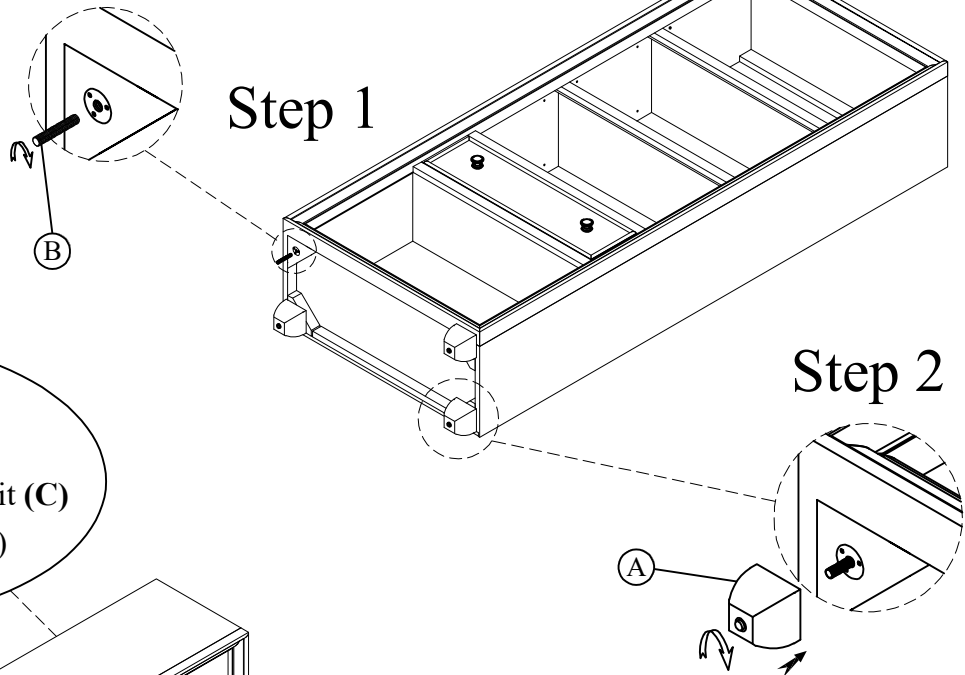

Step 3

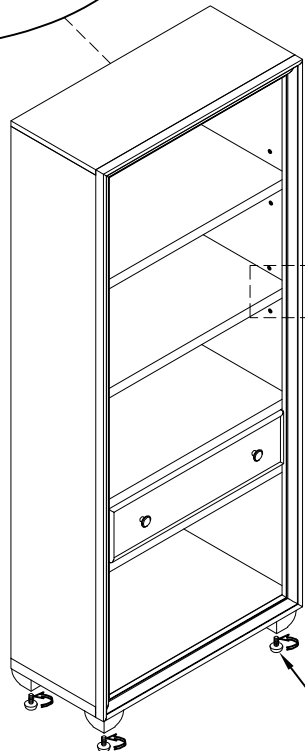

Step 4

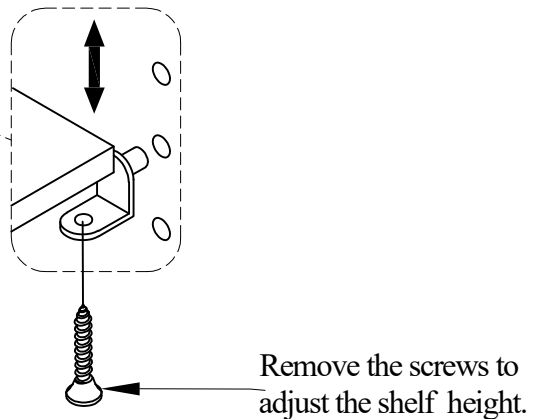

Adjustable Leveler

The levelers in the bottom of the Bun Feet can be adjusted if necessary to compensate for uneven flooring.