









PARTS LIST

<p>Chair Back (A) 1 PC.</p> 	<p>Seat Frame (B) 1 PC.</p> 	<p>Leg Front (Right/Left) (C) 2 PCS.</p> 	<p>Bolt $\phi 5/16" \times 2-1/2"$ (D) 4 PCS.</p> 	<p>Bolt $\phi 5/16" \times 2"$ (E) 4 PCS.</p> 
<p>Bolt $\phi 5/16" \times 1-1/2"$ (F) 2 PCS.</p> 	<p>Flat Washer $\phi 5/16" \times 19mm$ (G) 10 PCS.</p> 	<p>Spring washer $\phi 5/16"$ (H) 10 PCS.</p> 	<p>5mm Allen Wrench (I) 1 PC.</p> 	

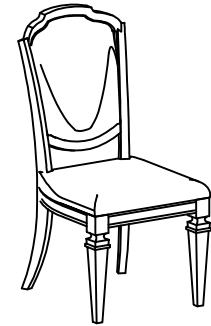

71656 - Uph Side Chair

Be sure to check all packing material carefully for small parts, which may have come loose inside the carton during shipment.

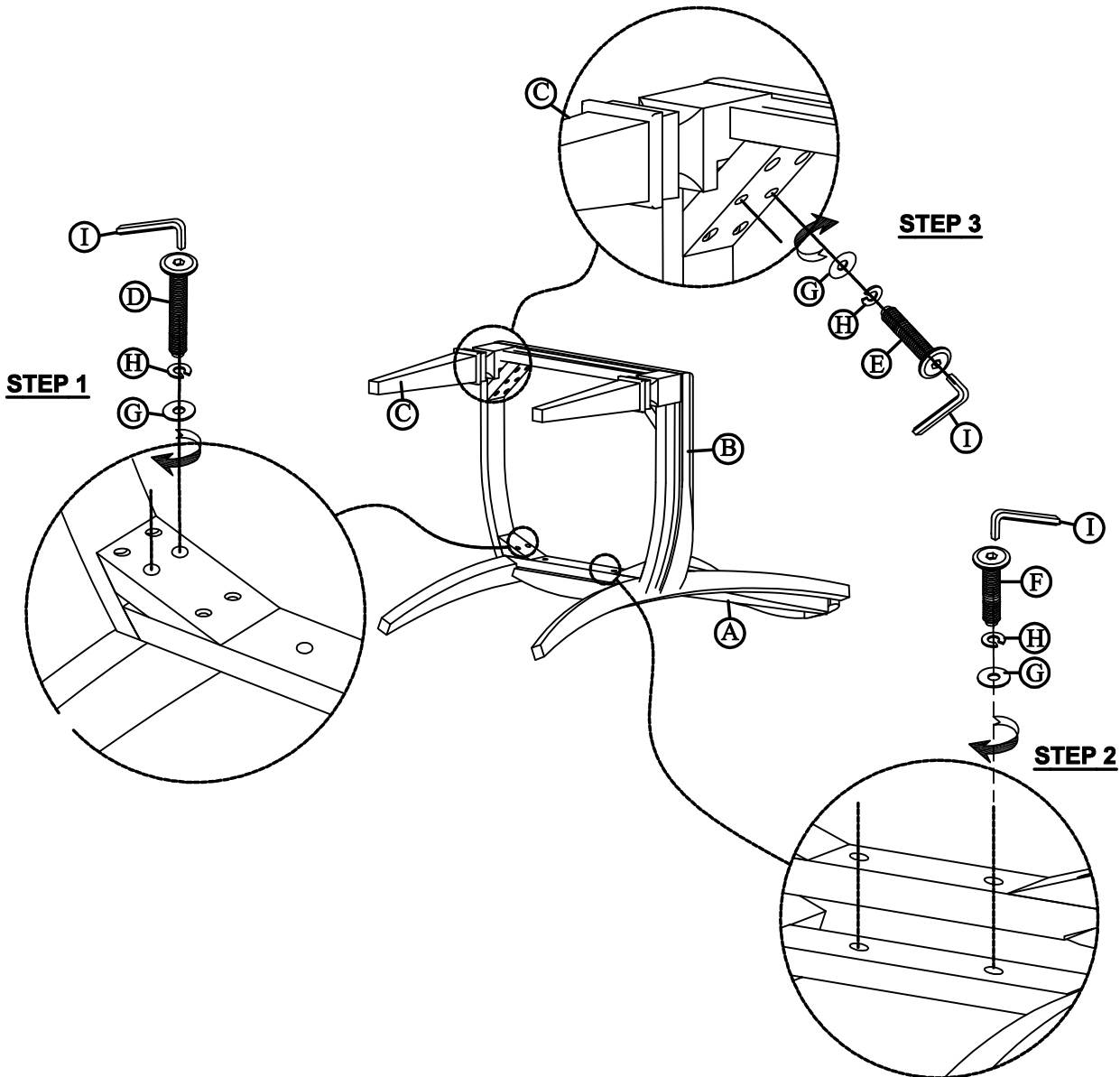

THANK YOU FOR YOUR PURCHASE.