

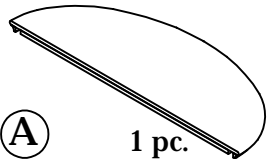

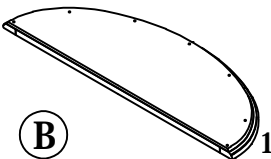

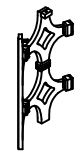

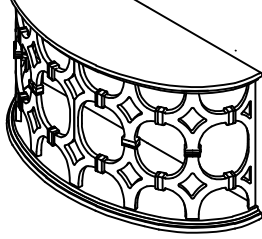

Components and Hardware List

<p>Top Frame</p>  <p>(A) 1 pc.</p>	<p>Bottom Frame</p>  <p>(B) 1 pc.</p>	<p>Left Frame Leg</p>  <p>(C) 1 pc.</p>	 <p>#71415 Demilune Sofa Table</p>	
<p>Center Frame Leg</p>  <p>(D) 3 pcs.</p>	<p>Right Frame Leg</p>  <p>(E) 1 pc.</p>	<p>Ø1/4-20 x 1-3/8" Allen Head Bolt</p>  <p>(F) 12 pcs.</p>		<p>Ø1/4" Spring Washer</p>  <p>(G) 14 pcs.</p>
<p>Ø1/4" x 16 x 2mm Flat Washer</p>  <p>(H) 14 pcs.</p>	<p>4mm Allen Key</p>  <p>(I) 1 pc.</p>	<p>#4 x 1" Wood Screw</p>  <p>(J) 8 pcs.</p>		<p>Ø1/4-20 x 3/4" Allen Head Bolt</p>  <p>(K) 2 pcs.</p>
<p>Furniture Tipping Restraint Kit</p>  <p>(L) 2 pcs.</p>				

Be sure to check all packing material carefully for small parts, which may have come loose inside the carton during shipment.
To prevent possible scratches and damage, this furniture should be assembled on a soft surface such as a blanket or carpet.

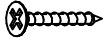
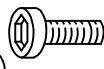
Step 1

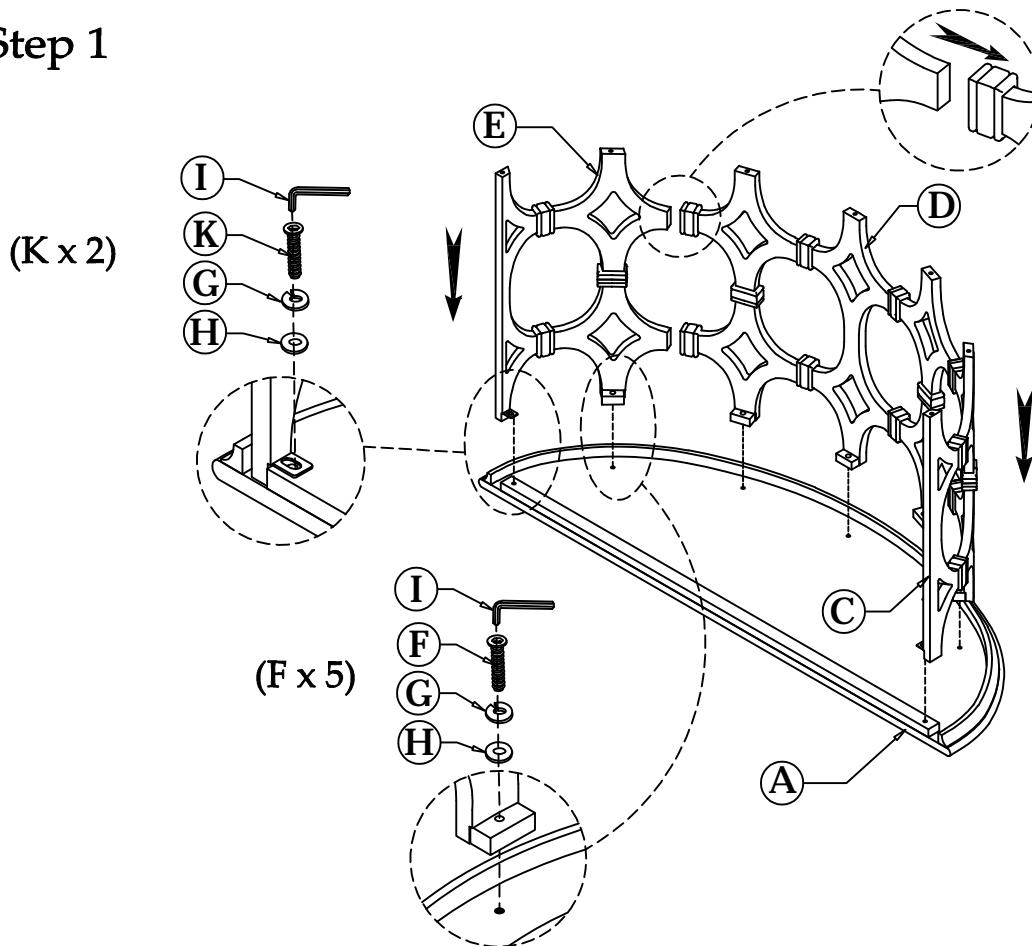

Step 2

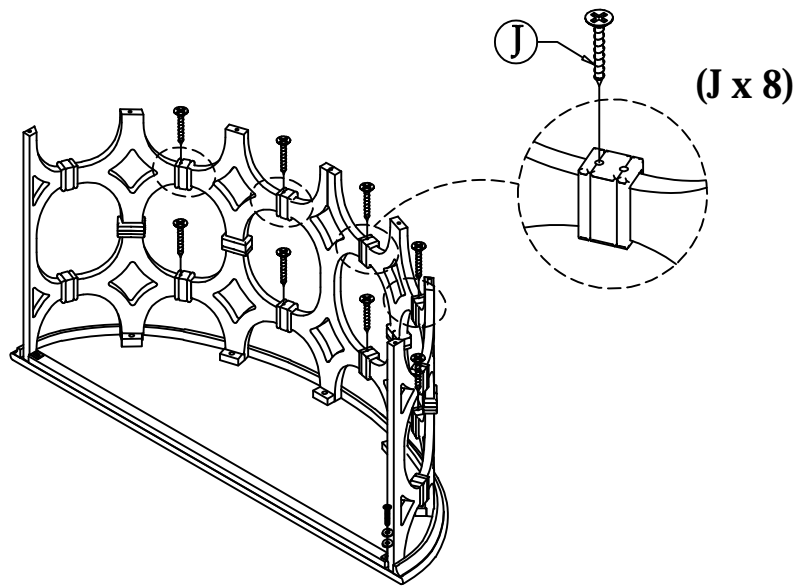

Step 3

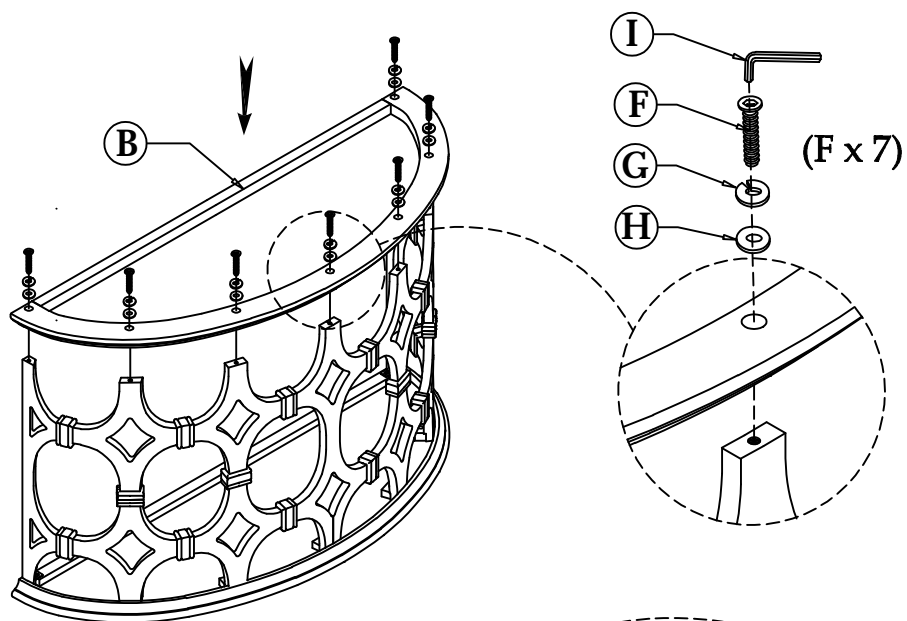

Step 4

For product and personal safety, Furniture Tipping Restraint Kits have been included with this unit which can help to minimize the risk of the unit accidentally tipping forward, if used and properly installed per the manufacturer's instructions.

