



















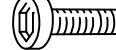

63448
PIER

Shelf 21 1/2" x 17"  (A) 3 pcs.	Shelf 21 1/2" x 14 3/4"  (B) 1 pc.	Shelf 21 1/2" x 13"  (C) 1 pc.	Shelf 21 1/2" x 11"  (D) 1 pc.	 (E) 1 pc.	 (F) 1 pc.	8 x 14 x 2mm Spring Washer  (G) 34 pcs.	8 x 23 x 1.75 mm Flat Washer  (H) 4 pcs.	 (M) 1 pc.
R/H End Assembly  (E) 1 pc.	L/H End Assembly  (F) 1 pc.	6 x 16 x 1 mm Flat Washer  (I) 30 pcs.	Ø 5 mm x 16mm" Allen Head Bolt  (J) 30 pcs.			5 mm x 25 mm Allen Head Bolt  (K) 4 pcs.	5mm Allen Wrench  (L) 1 pc.	
6 x 16 x 1 mm Flat Washer  (I) 30 pcs.	Ø 5 mm x 16mm" Allen Head Bolt  (J) 30 pcs.	5 mm x 25 mm Allen Head Bolt  (K) 4 pcs.	5mm Allen Wrench  (L) 1 pc.			Back X-Frame  (M) 1 pc.		
Furniture Tipping Restrain Kit  (N) 1 pc.								

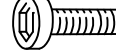
Be sure to check all packing material carefully for small parts, which may have come loose inside the carton during shipment.

To prevent possible scratches and damage, this furniture should be assembled on a soft surface such as a blanket or carpet.

Step 1: Lay the Metal Leg (E) - 1pc on a soft surface. Match the Shelf (A,B,C,D,) as per assembly and fasten the same using Flat washer (I) Spring Washer (G) and Allen head bolt (J) with Allen Wrench (L)

Step- 2: Attach the other Metal Leg (F) to the half assembled product. To fasten the shelves (A,B,C,D) to the Metal Leg (E) follow the process of step 1.

Step 3: Stand the pier upright and attach the Back X Frame (M) at the back with Spring Washer (G), Flat Washer (H) and Allen head bolt (K) with Allen Wrench (L).

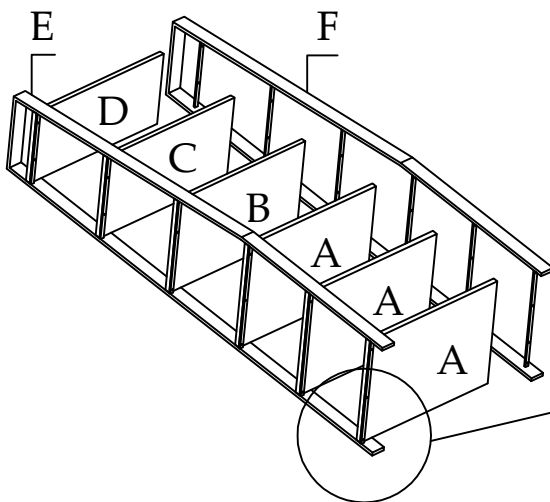

STEP 1

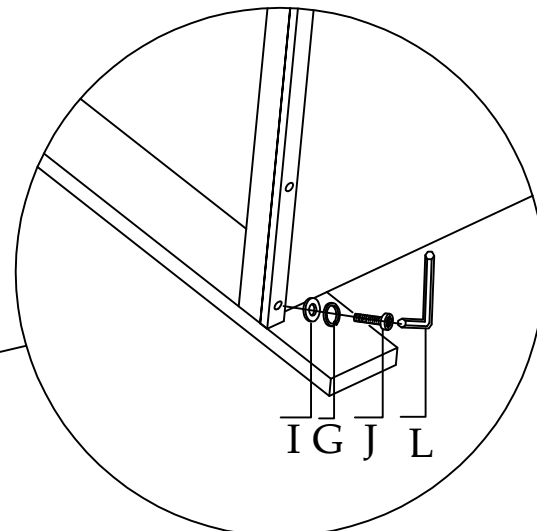

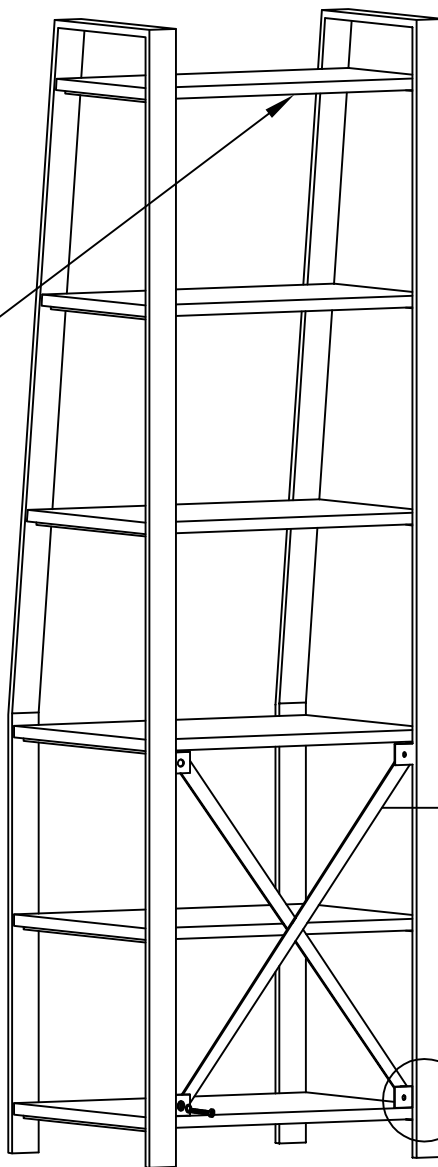

M

STEP 2

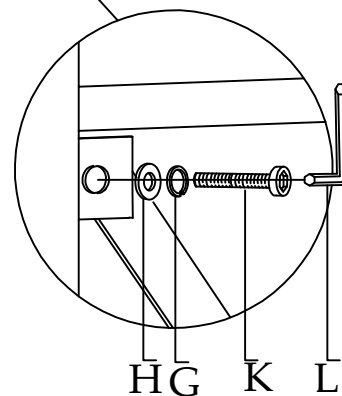

H G K L