

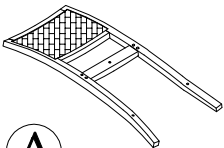

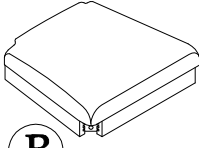

Components and Hardware List (for one chair)

<p>Back Assembly</p>  <p>A 1 pc.</p>	<p>Chair Seat</p>  <p>B 1 pc.</p>	<p>Front Leg</p>  <p>C 1-Left 1-Right</p>	<p>Side Stretcher</p>  <p>D 1-Left 1-Right</p>
<p>Front Stretcher</p>  <p>E 1 pc.</p>	<p>M5/16"-18 x 3" Allen Head Bolt</p>  <p>F 4 pcs.</p>	<p>M5/16"-18 x 1-3/4" Allen Head Bolt</p>  <p>G 1 pc.</p>	<p>M5/16"-18 x 2" Allen Head Bolt</p>  <p>H 4 pcs.</p>
<p>5/16" Spring Washer</p>  <p>I 9 pcs.</p>	<p>5/16" x 19 x 2mm Flat Washer</p>  <p>J 9 pcs.</p>	<p>5mm Allen Wrench</p>  <p>K 1 pc.</p>	<p>#8 x 1-1/2" Wood Screw</p>  <p>M 6 pcs.</p>

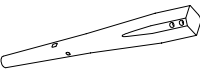
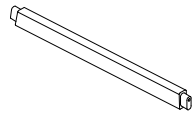
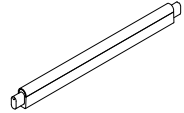
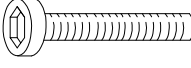
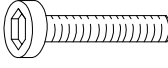
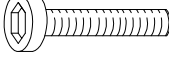

#63054
Gather Ht Uph Chair 2in

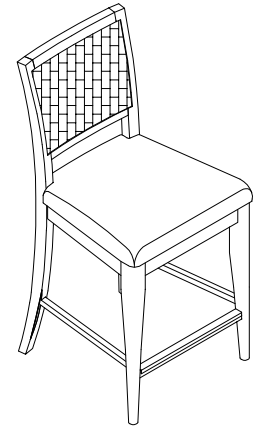
Be sure to check all packing material carefully for small parts, which may have come loose inside the carton during shipment.

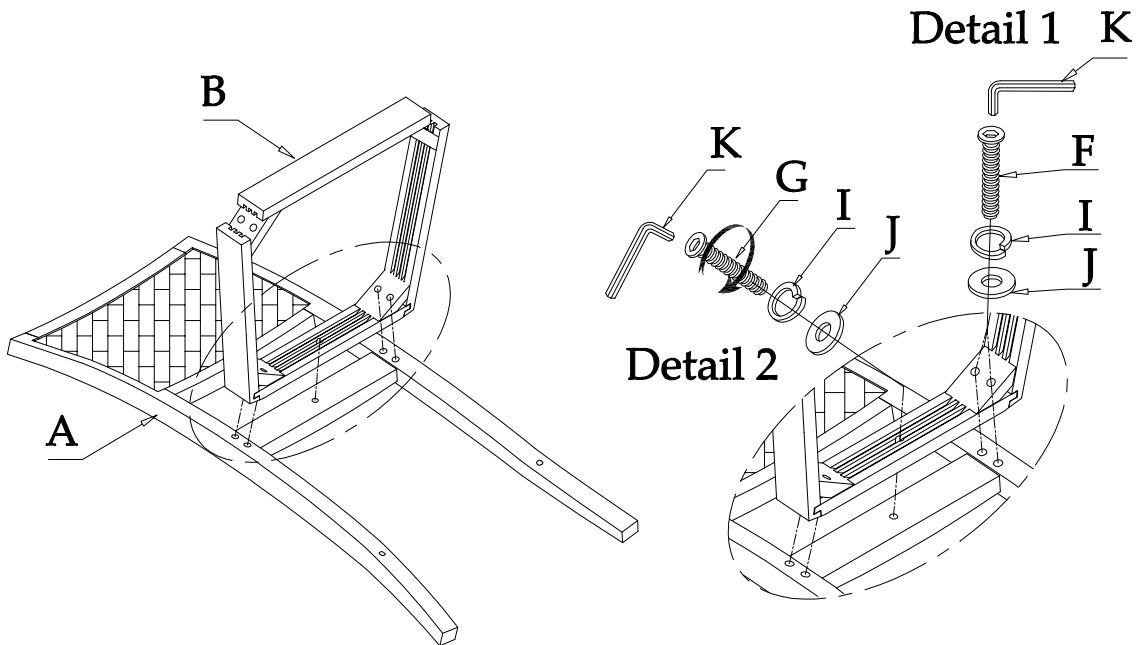

Steps:

1. Place the Back Assembly (A) on a soft and smooth surface.
2. Attach Chair Seat (B) to the Back Assembly (A) by using Bolt (F), Spring Washer (I) and Flat Washer (J) into the back corners of the Seat, as shown in Detail 1. Using Bolt (G), Spring Washer (I) and Flat Washer (J) into the middle of the Seat, as shown Detail 2. **Do not fully tighten Bolts until after next step.**

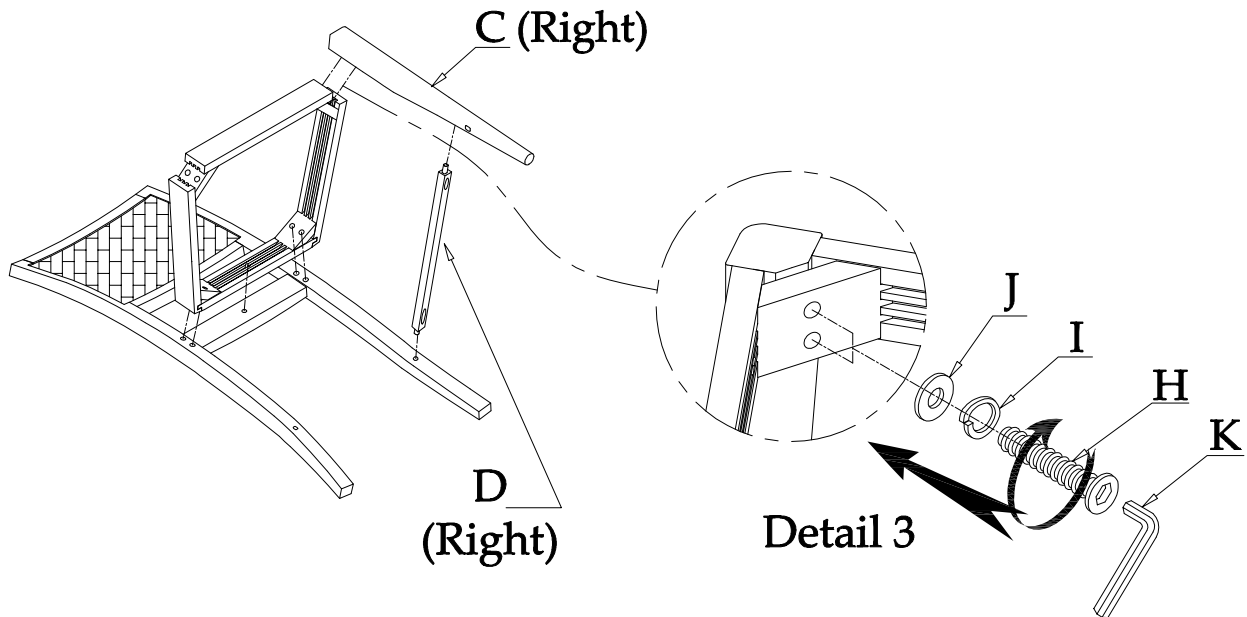

- 3: Assemble the Left and Right Front Legs (C) to the Chair Seat by using Bolt (H), and the same washers as before as shown in Detail 3.
- 4: Install the Right & Left Side Stretchers (D) into the Back Assembly (A) and front legs (C) and the Front Stretcher (E) between the Front Legs (C) as shown in Detail 4. Do not install wood screws until step 5 has been completed.
- 5: Set the assembled Chair upright on a flat surface to level chair. Reach underneath the Seat and tighten all Bolts using the Allen Wrench (K).
- 5: While pulling the Legs and Stretchers snugly together and using your Phillips Screwdriver, install the Wood Screws (M) at each end of the Stretchers.

