

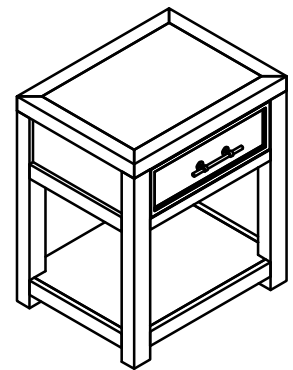

Warning :

- Be sure to check all packing material carefully for small parts, which may have come loose inside the carton during shipment.
- To prevent possible scratches and damage, this furniture must be assembled on a soft surface such as a blanket or carpet.

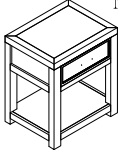

#50568
1-Drawer Nightstand

Components and Hardware List

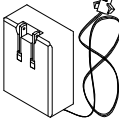
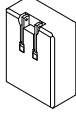
<p>(A)  Nightstand 1 pc.</p>	<p>(B)  Furniture tipping restraint kit 1 pc.</p>	<p>(C)  Lighting Adapter 1 pc.</p>	<p>(D)  USB Adapter 1 pc.</p>
---	--	---	---

Step 1

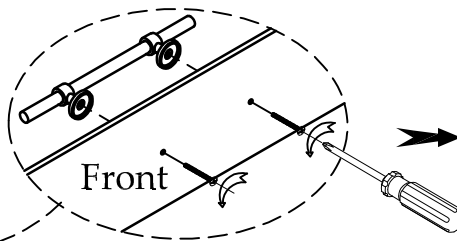
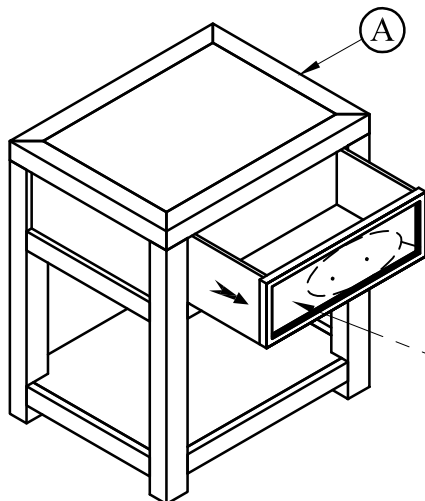

Remove Handle from inside drawer

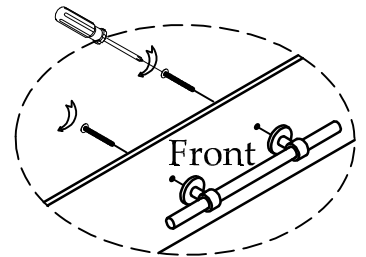

Reattach Handle to outside of drawer

Attention :

- Part C - Lighting Adapter is packaged inside of drawer.
- Part D - USB Adapter is packaged inside of drawer.
- Plug each of the adapters into the appropriate wires located on the back of the case to use.

Step 2

