

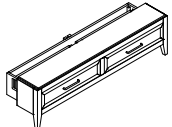

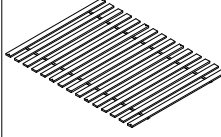

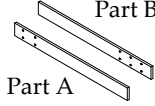

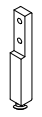

### Hardware and Parts packed with the King Storage Footboard

<b>King Storage Footboard</b>  <b>(F-A)</b> 1 pc.	<b>King Roll Slat (77" X 80-7/8")</b>  <b>(F-B)</b> 1 pc.	<b>Slat Support Rails</b>  <b>(F-C)</b> 2 pcs.	<b>Slat Support Leg</b>  <b>(F-D)</b> 1 pc.
<b>Drawer Box Support Leg 8-3/4" long with leveler</b>  <b>(F-E)</b> 2 pcs.	$\phi\frac{5}{16}$ -18 x 1-1/2" Long Allen Head Bolt  <b>(F-F)</b> 6 pcs.	$\phi\frac{5}{16}$ -18 x 2-3/4" Long Allen Head Bolt  <b>(F-G)</b> 2 pcs.	$\phi\frac{5}{16}$ x 12 x 3mm Spring Washer  <b>(F-H)</b> 8 pcs.
$\phi\frac{5}{16}$ x 19 x 2mm Flat Washer  <b>(F-I)</b> 8 pcs.	#8 x 1" Wood Screw  <b>(F-J)</b> 8 pcs.	5mm Allen Wrench  <b>(F-K)</b> 1 pc.	

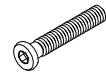

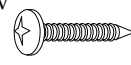
46180  
6/0-6/6 UPH HEADBOARD

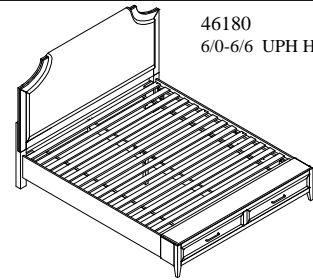
46183 6/0-6/6 UPH BENCH STORAGE FOOTBOARD  
46172 5/0-6/6 BED RAILS --OR--  
46182 6/0 BED RAILS

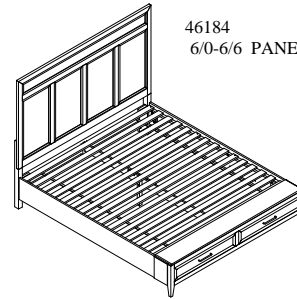

46184  
6/0-6/6 PANEL HEADBOARD

46183 6/0-6/6 UPH BENCH STORAGE FOOTBOARD  
48172 5/0-6/6 BED RAILS --OR--  
46182 6/0 BED RAILS



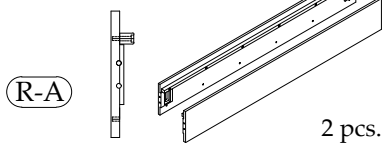

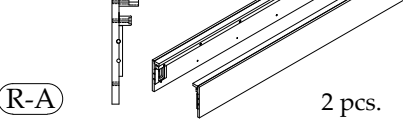

### Queen / Eastern King Bed Rail



### California King Bed Rail



### Hardware and Parts packed with the 5/0-6/6 Bed Rails and the 6/0 Bed Rails

$\phi\frac{5}{16}$ -18 x 3-1/2" Long All-Thread Bolt  <b>(R-B)</b> 8 pcs.	$\phi\frac{5}{16}$ -18 Hex Nut  <b>(R-C)</b> 8 pcs.	$\phi\frac{5}{16}$ x 12 x 3mm Spring Washer  <b>(R-D)</b> 8 pcs.	M5/16" x 16*2mm Flat Washer  <b>(R-E)</b> 8 pcs.
12mm Open Wrench  <b>(R-F)</b> 1 pc.	4mm Allen Wrench  <b>(R-G)</b> 1 pc.	<p>Be sure to check all packing material carefully for small parts, which may have come loose inside the carton during shipment. To prevent possible scratches or damage, this furniture should be assembled on a soft surface such as a blanket or carpet. To prevent possible damage to furniture and personal injury, it is recommended that two people are used to assemble and set-up this bed.</p>	

Note: For a Storage Bed, the Wood Slat Support Cleat mounted on the back side of the Bed Rails must be mounted at the upper location. If needed, using the Allen Wrench (R-G) remove the Bolts and Washers and remount it at the upper position on the Bed Rails. It is mounted at the lower position for a Standard Bed.

The Filler Rail mounted at the top edge of the California King Bed Rails must also be temporarily removed to assemble the Slats on the Bed.

#### ASSEMBLY STEPS :

1. Place the Storage Footboard (F-A) face down on a clean and soft surface.
2. Attach the Drawer Box Support Legs (F-E) using the Flat Washers (F-I), Spring Washers (F-H) and 1-1/2" long Bolts (F-F). Tighten with the Allen Wrench (F-K). See Detail A.

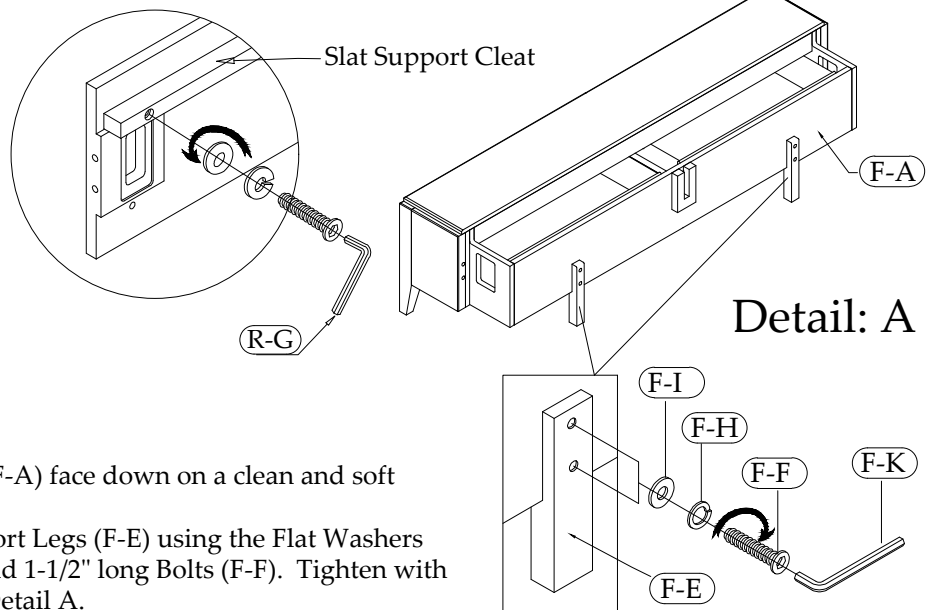

46180  
TALL UPH HEADBOARD

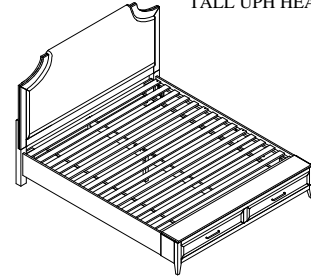

46183 STORAGE FOOTBOARD  
46172 5/0-6/6 BED RAILS --OR--  
46182 6/0 BED RAILS

46184  
TALL PANEL HEADBOARD

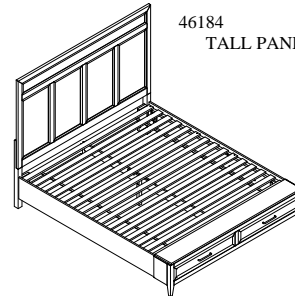

46183 6/0-6/6 STORAGE FOOTBOARD  
48172 5/0-6/6 BED RAILS --OR--  
46182 6/0 BED RAILS

- Lean the back of the Headboard against the wall where the Bed will be assembled.
- Install two All-Thread Bolts (R-B) into the metal threaded inserts installed in the Headboard Legs and into the metal inserts on the Footboard.
- Carefully position one end of one Bed Rail (R-A) onto the All-thread Bolts on the Headboard and connect using the Flat Washers (R-E), Spring Washers (R-D), and Hex Nut (R-C). Only partially tighten the Nuts until the Footboard has been connected. Repeat for other Bed Rail.
- Position and connect the Footboard (F-A) to the other end of the Bed Rails, attaching as in the previous Steps.
- Carefully align the Footboard to be 'square' with the Headboard. Using the Open Wrench (R-F) tighten all Hex Nuts attaching the Side Rails to the Headboard and Footboard. (See Detail E).

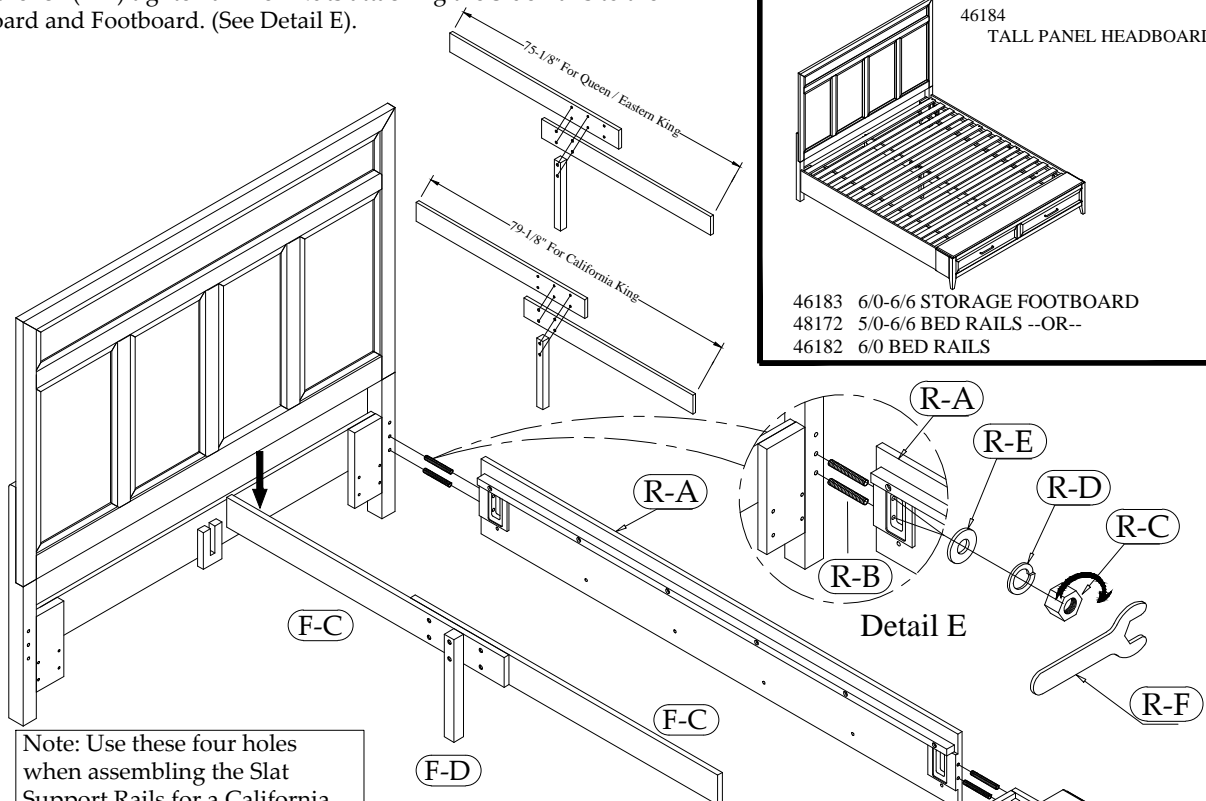

Note: Use these four holes when assembling the Slat Support Rails for a California King Bed.

Note: Use these four holes when assembling the Slat Support Rails for a Queen or Eastern King Bed.

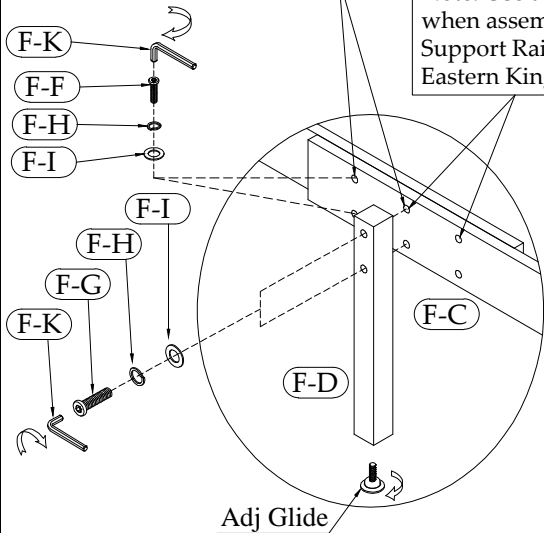

Adj Glide

STEP 3

NOTE: The Slat Support Rails Parts A & B, and Support Leg, can be assembled to fit a Queen/King Bed or to fit a California King Bed length, depending on the sets of holes used.

- Assemble Parts A & B of the Slat Support Rails (F-C) using the two 1-1/2" long Bolts (F-F), Spring Washers (F-H) and Flat Washers (F-I). Assemble the Slat Support Leg (F-D) to the Support Rails using the two 2-3/4" Long Bolts (F-K) and the same Washers. Tighten all four Bolts with the Allen Wrench (F-K).
- Position the Slat Support assembly into the pockets on the Headboard and Footboard.

46180  
6/0-6/6 UPH HEADBOARD

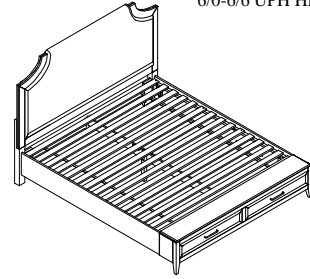

46183 6/0-6/6 UPH BENCH STORAGE FOOTBOARD  
46172 5/0-6/6 BED RAILS --OR--  
46182 6/0 BED RAILS

46184  
6/0-6/6 PANEL HEADBOARD

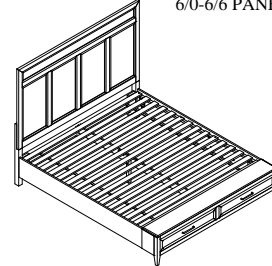

46183 6/0-6/6 UPH BENCH STORAGE FOOTBOARD  
48172 5/0-6/6 BED RAILS --OR--  
46182 6/0 BED RAILS

After the Bed is assembled, completely unroll the Bed Roll Slat (F-B) onto the Bed.

*For an Eastern King Bed, disregard Steps 1 and 3 shown below.*

Using your Phillips Screwdriver, attach the Slats nearest the Headboard and Footboard and attach the middle of the Slats to the Slat Support Rails in the middle of the Bed using the 1" Long Wood Screws (F-I).

Steps 1 and 3 below apply for California King Bed Rails only. These Bed Rails use a wood filler attached to the top inside edge of the Bed Rails, which must be removed using the Allen Wrench supplied with the Bed Rails (Step 1 below), install the Bed Slats (Step 2 below) and then reattach the filler rails (Step 3 below).

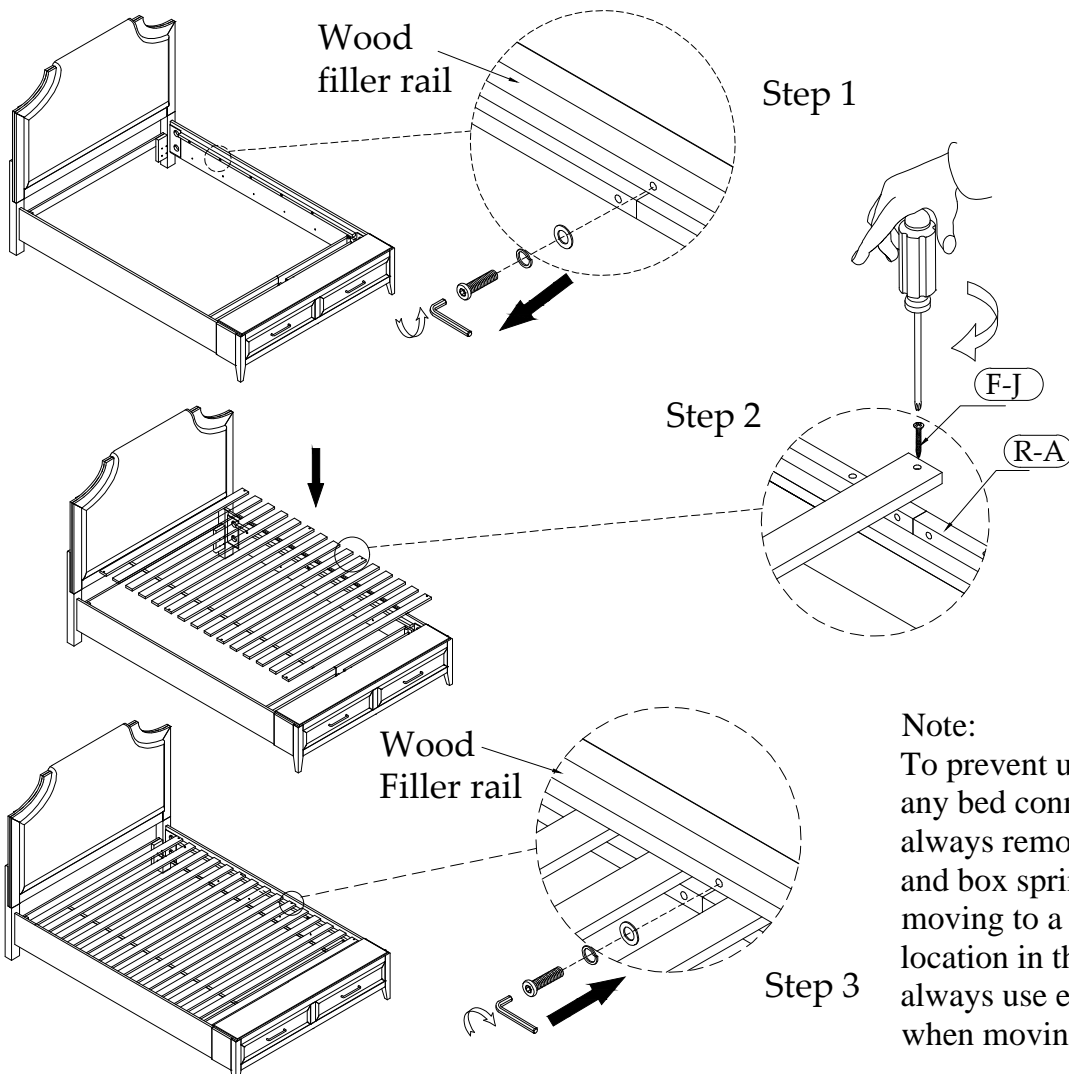

**Note:**  
To prevent undue stress on any bed connection joints, always remove the mattress and box springs before moving to a different location in the room and always use extreme care when moving.