

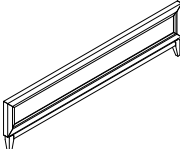

Hardware and Parts packed with the Queen Storage Footboard

<p>Queen Footboard</p>  <p>(F-A) 1 pc.</p>	<p>5/0 Wood Slat 61" Long</p>  <p>(F-B) 4 pcs.</p>	<p>Slat Support Leg 9-1/2" long with leveler</p>  <p>(F-C) 4 pcs.</p>	<p>#8 x 1" Wood Screw</p>  <p>(F-D) 8 pcs.</p>

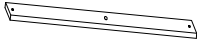



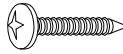
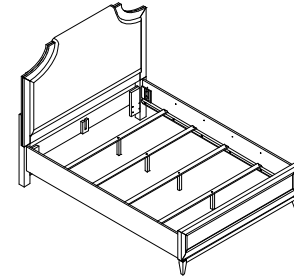
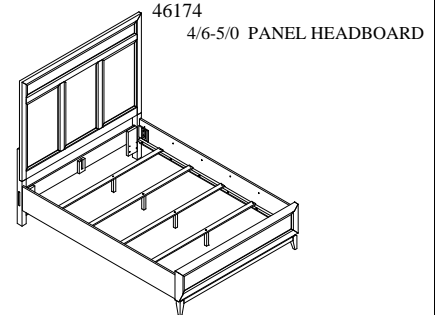



46175 5/0 PANEL FOOTBOARD
46172 5/0-6/6 BED RAILS

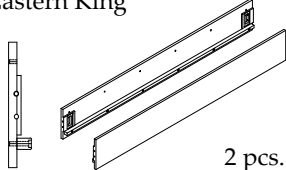

46175 5/0 PANEL FOOTBOARD
46172 5/0-6/6 BED RAILS

Hardware and Parts packed with the 5/0-6/6 Bed Rails

<p>Queen / Eastern King Bed Rail</p>  <p>(R-A) 2 pcs.</p>	<p>$\phi_{5/16}$-18 x 3-1/2" Long All-Thread Bolt</p>  <p>(R-B) 8 pcs.</p>	<p>$\phi_{5/16}$-18 Hex Nut</p>  <p>(R-C) 8 pcs.</p>	<p>$\phi_{5/16}$ x 12 x 3mm Spring Washer</p>  <p>(R-D) 8 pcs.</p>	<p>M5/16" x 19*2mm Flat Washer</p>  <p>(R-E) 8 pcs.</p>
<p>12mm Open Wrench</p>  <p>(R-F) 1 pc.</p>	<p>4mm Allen Wrench</p>  <p>(R-G) 1 pc.</p>			

Be sure to check all packing material carefully for small parts, which may have come loose inside the carton during shipment. To prevent possible scratches or damage, this furniture should be assembled on a soft surface such as a blanket or carpet. It is recommended that two people are used to assemble and set-up this bed.

Note: For a Standard Bed, the Wood Slat Support Cleat mounted on the back side of the Bed Rails must be mounted at the lower location. If needed, using the Allen Wrench (R-G) remove the Bolts and Washers and remount it at the lower position on the Bed Rails.

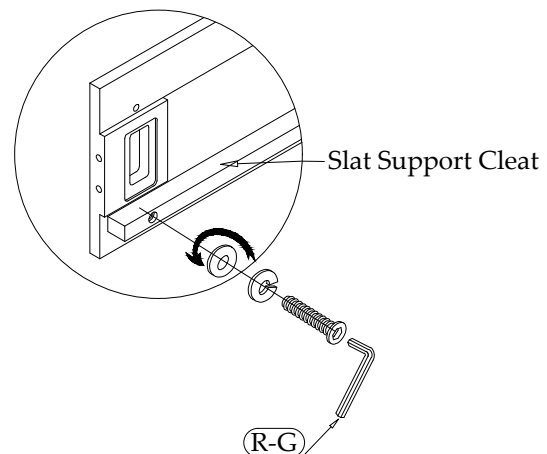

46170

LOW UPH HEADBOARD

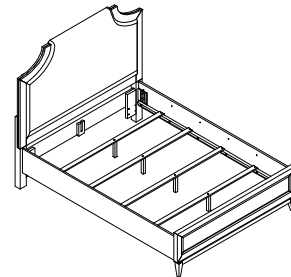

46175 5/0 FOOTBOARD

46172 5/0-6/6 BED RAILS

46174

LOW PANEL HEADBOARD

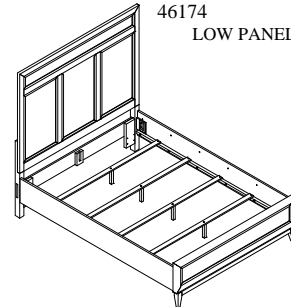

46175 5/0 FOOTBOARD

46172 5/0-6/6 BED RAILS

Steps:

1. Lean the back of the Headboard against the wall where the Bed will be assembled.
2. Install two All-Thread Bolts (R-B) into the metal threaded inserts installed in the Headboard Legs and into the metal inserts on the Footboard.
3. Carefully position one end of one Bed Rail (R-A) onto the All-thread Bolts on the Headboard and connect using the Flats Washers (R-E), Spring Washers (R-D), and Hex Nut (R-C). Only partially tighten the Nuts until the Footboard has been connected. Repeat for other Bed Rail.
4. Position and connect the Footboard (F-A) to the other end of the Bed Rails, attaching as in the previous Steps.
5. Carefully align the Footboard to be 'square' with the Headboard. Using the Open Wrench (R-F) tighten all Hex Nuts attaching the Side Rails to the Headboard and Footboard. (See Detail E).

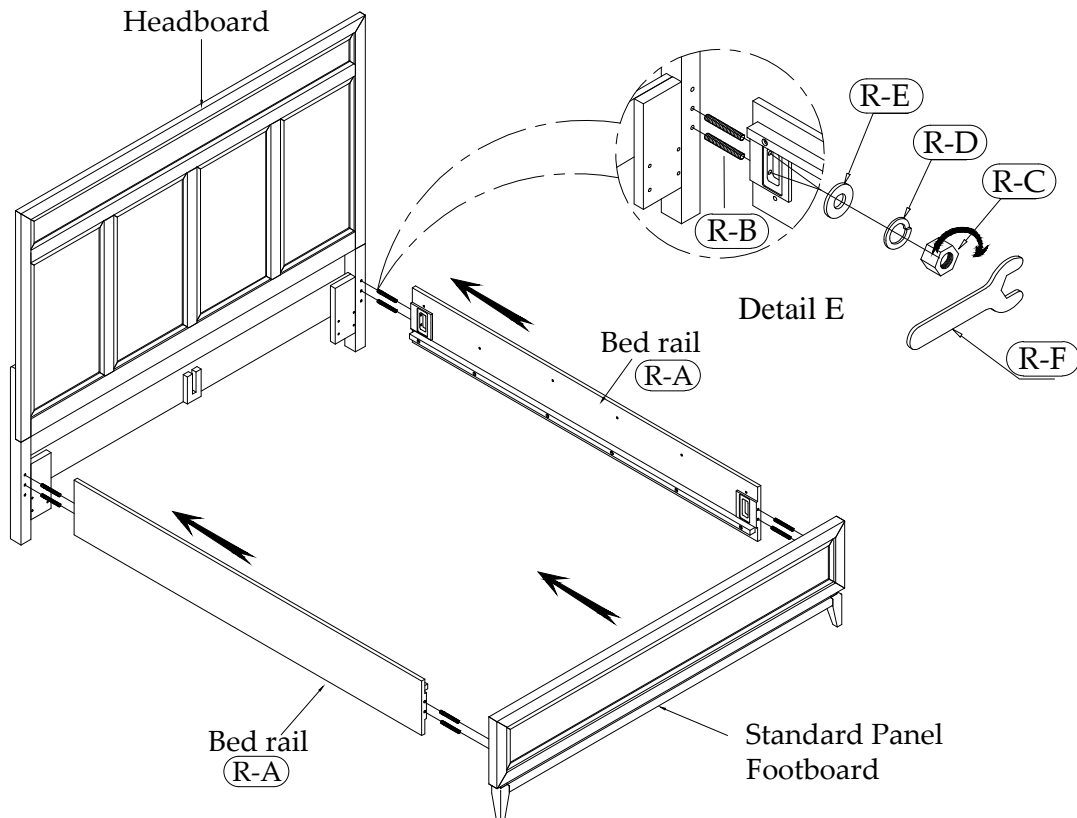

46170
LOW UPH HEADBOARD

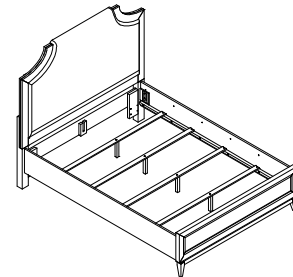

46175 5/0 FOOTBOARD
46172 5/0-6/6 BED RAILS

46174
LOW PANEL HEADBOARD

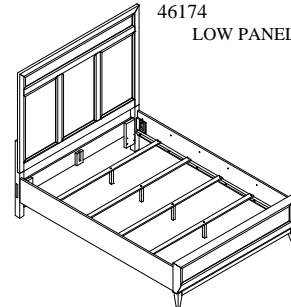

46175 5/0 FOOTBOARD
46172 5/0-6/6 BED RAILS

6. Attach the four Slat Support Legs (F-C) to the bottom side of four Wood Slats (F-B). (See Detail F).
 7. Position and attach the Slats to the Bed Rails using the Wood Screws (F-D) and your Phillips Screwdriver.
- The levelers located at the bottom of the Support Legs can be adjusted if necessary to support the Slats.

Using your Phillips Screwdriver, attach the Slats nearest the Headboard and Footboard and attach the middle of the Slats to the Slat Support Rails in the middle of the Bed using the 1" Long Wood Screws (F-I).

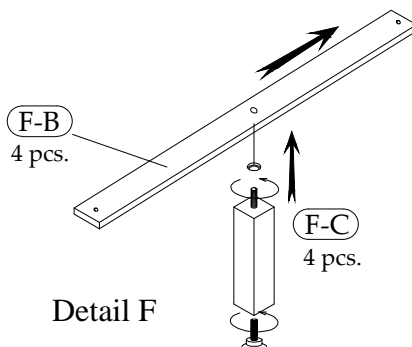
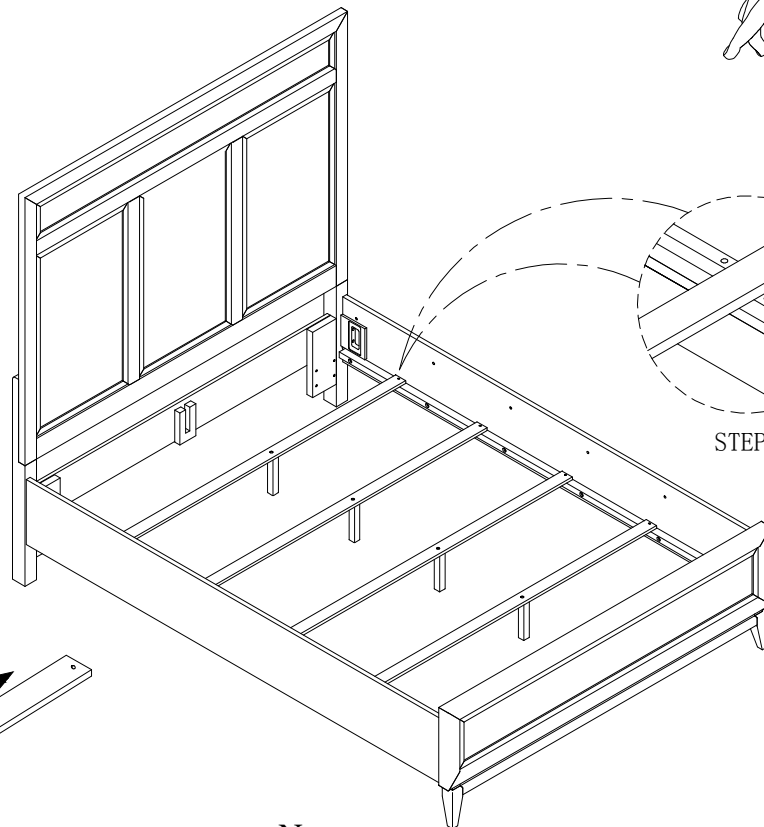

Note:
To prevent undue stress on any bed connection joints, always remove the mattress and box springs before moving to a different location in the room and always use extreme care when moving.