











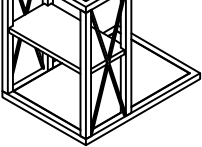
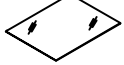

Components and Hardware List

<p>Top Frame</p>  <p>(A) 1 pc.</p>	<p>Side Frames</p>  <p>(B) 2 pcs.</p>	<p>Bottom</p>  <p>(C) 1 pc.</p>	<p>Center Shelf</p>  <p>(D) 1 pc.</p>	 <p>41408 Rectangle End Table</p>
<p>Glass</p>  <p>(E) 1 pc.</p>	<p>Ø1/4 x 16mm Allen Head Bolt</p>  <p>(F) 4 pcs.</p>	<p>1/4" x 11 x 1.2mm Spring Washer</p>  <p>(G) 4 pcs.</p>	<p>1/4" x 16 x 1mm Flat Washer</p>  <p>(H) 4 pcs.</p>	
<p>4mm Allen Key</p>  <p>(I) 1 pc.</p>	<p>Black Felt pad</p>  <p>(J) 4 pcs.</p>	<p>Threaded Pin</p>  <p>(K) 8 pcs.</p>	<p>5mm Allen Key</p>  <p>(L) 1 pc.</p>	

Be sure to check all packing material carefully for small parts, which may have come loose inside the carton during shipment.

To prevent possible scratches and damage, this furniture should be assembled on a soft surface such as a blanket or carpet.

STEP 1

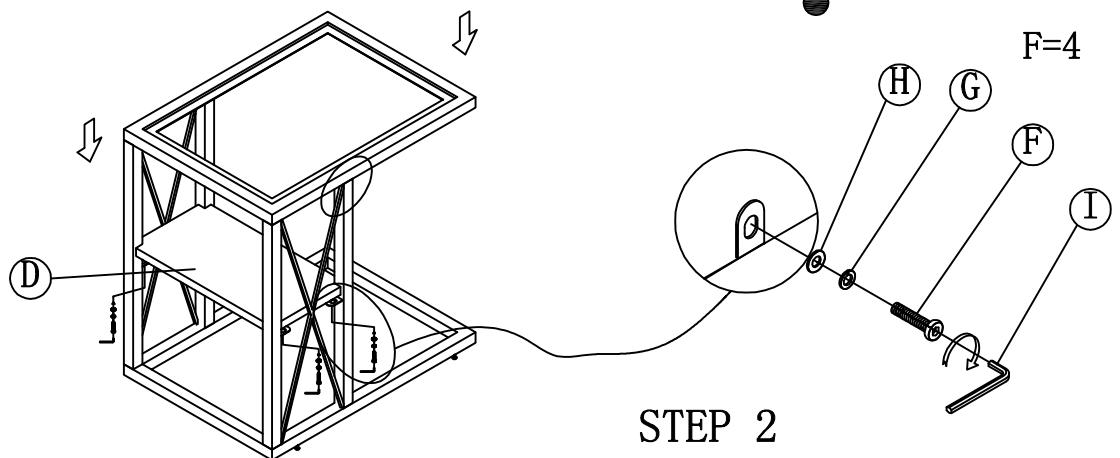
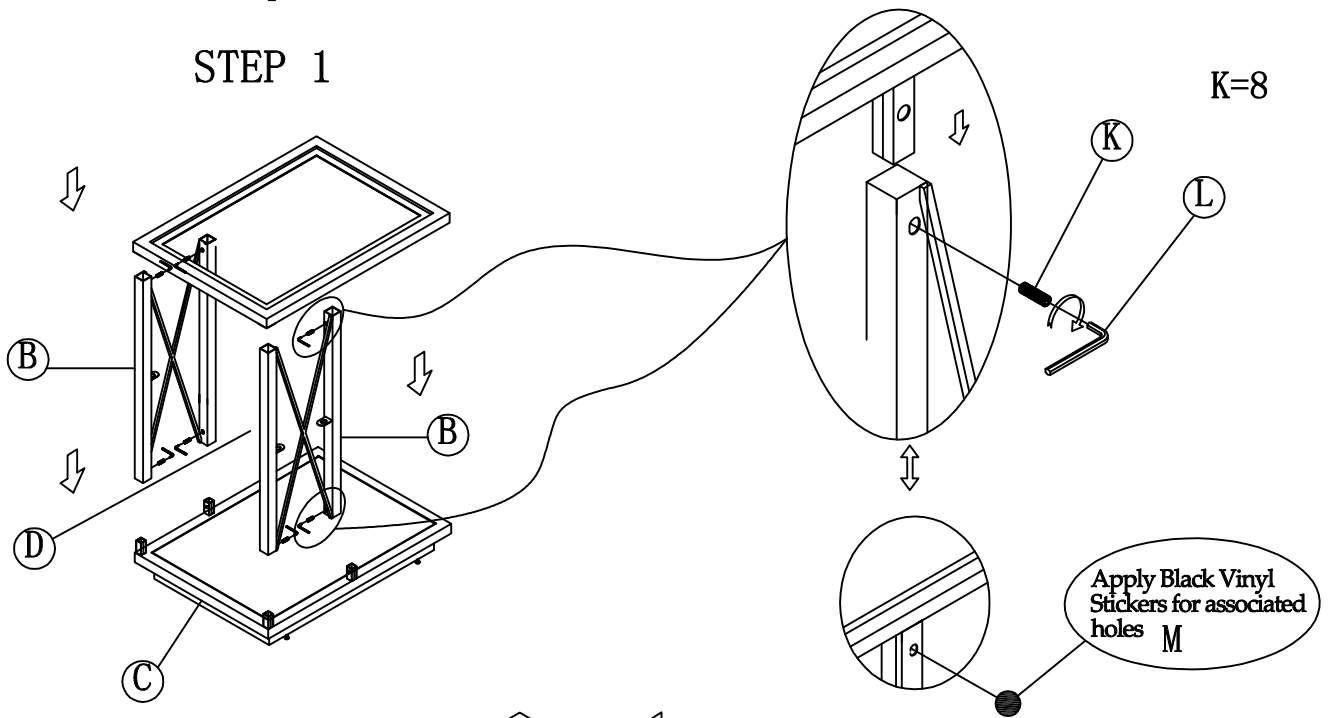

Apply Black Felt Pads

J

STEP 3

E

STEP 4

Adjustable
leveler

