

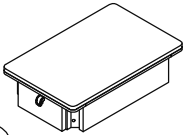

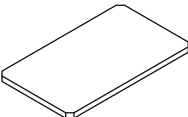

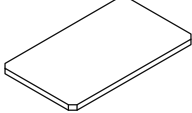



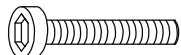

**Components and Hardware List**

| Leg  | Table Top  | Top Shelf   | Bottom Shelf  |
|--|--|---|---|
| <br><b>(A)</b> 4 pcs.                           | <br><b>(B)</b> 1 pc.  | <br><b>(C)</b> 1 pc.   | <br><b>(D)</b> 1 pc.  |
| <b>L-Bracket</b><br><br><b>(E)</b> 8 pcs.       | <b>M5/16"-18 x 2-1/4" Allen Head Bolt</b><br><br><b>(F)</b> 8 pcs. | <b>5/16" Spring Washer</b><br><br><b>(G)</b> 8 pcs. | <b>5/16" *19*2mm Flat Washer</b><br><br><b>(H)</b> 8 pcs. |
| <b>5mm Allen Wrench</b><br><br><b>(I)</b> 1 pc. | <b>M1/4"-20 x 5/8" Allen Head Bolt</b><br><br><b>(J)</b> 16 pcs.     | <b>1/4" Spring Washer</b><br><br><b>(K)</b> 16 pcs. | <b>1/4" *16*2mm Flat Washer</b><br><br><b>(L)</b> 16 pcs.  |
|  |  |   | <b>4mm Allen Wrench</b><br><br><b>(M)</b> 1 pc.   |

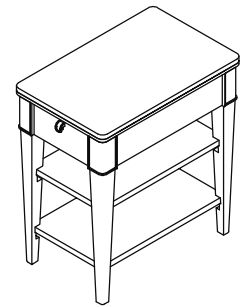

**#39412**  
**Chairside Table**

Be sure to check all packing material carefully for small parts, which may have come loose inside the carton during shipment.

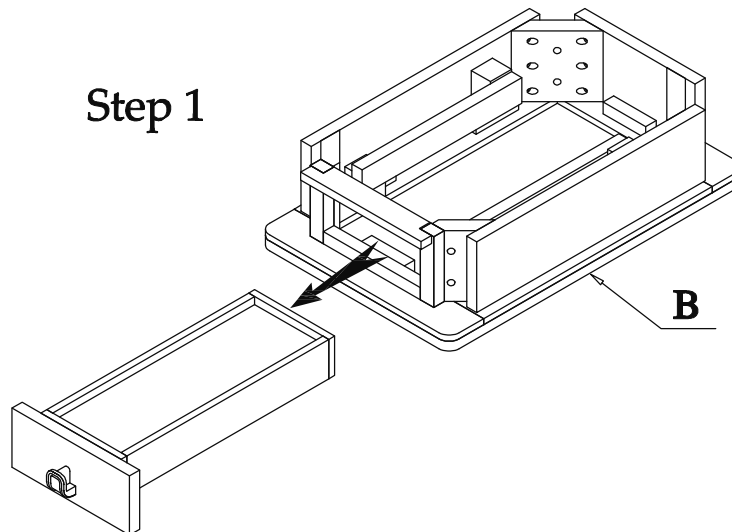

Step 2

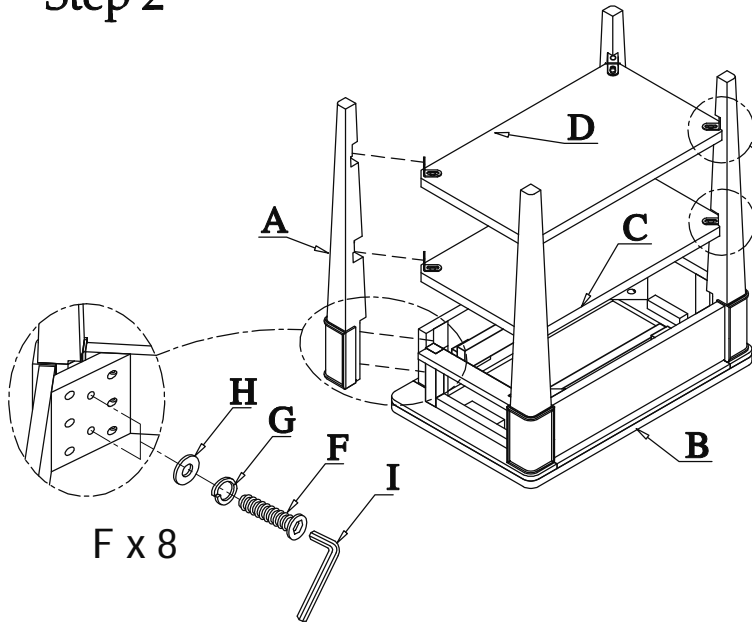

Step 3 & Step 4

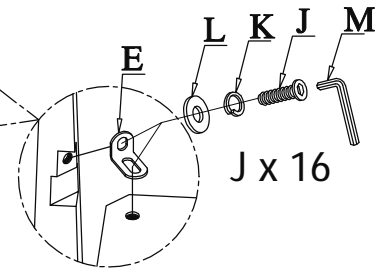

Step 5

