

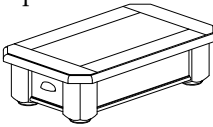
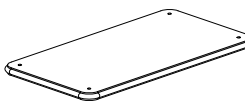
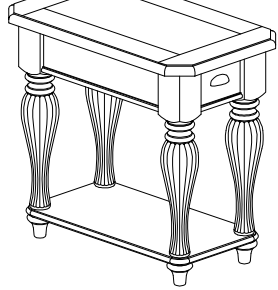

Components and Hardware List

<p>Table Top</p>  <p>(A) 1 pc.</p>	<p>Bottom Shelf</p>  <p>(B) 1 pc.</p>	 <p>#32512 <i>Chairside Table</i></p>
<p>Post</p>  <p>(C) 4 pcs.</p>	<p>Base Foot</p>  <p>(D) 4 pcs.</p>	

Be sure to check all packing material carefully for small parts, which may have come loose inside the carton during shipment.

ASSEMBLY STEPS:

1. Carefully place the Table Top upside down on a clean, soft surface such as a blanket or carpet.
2. Attach a Post (C) to each corner of the Table Top and tighten hand tight.
3. Attach the Bottom Shelf to the bottom of the Posts using the Base Feet (D) and tighten hand tight.
4. Carefully set the assembled table upright.

Step 1 & 2

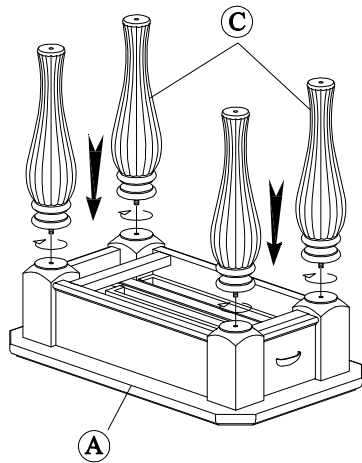

Step 3

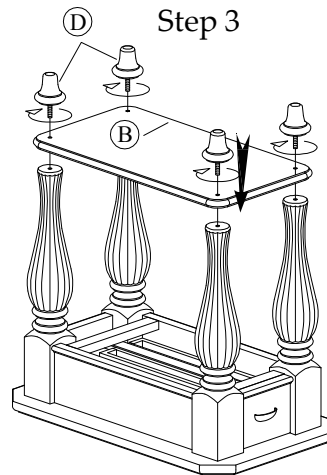

Step 4

