

## Components and Hardware List

End Frame

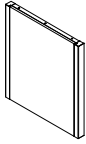

(A) 1 pc.

Desk Top

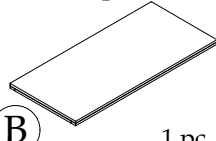

(B) 1 pc.

L-Shaped Angles



(C) 3 pcs.

$\frac{1}{4}$ "-20 x 17mm  
Allen Head Bolt

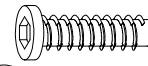

(D) 12 pcs.

28033 / 28133 / 28233

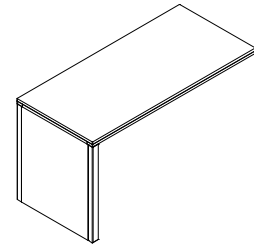

$\frac{1}{4}$ " Spring Washer



(E) 12 pcs.

$\frac{1}{4}$ " x 19 x 2mm  
Flat Washer



(F) 12 pcs.

4mm Allen Key



(G) 1 pc.

Wood Dowel  
Ø 10 x 30mm



(H) 2 pcs.

28034 / 28134 / 28234

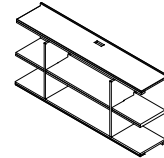

Connector Plate

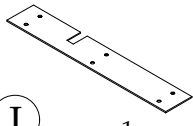

(I) 1 pc.

Be sure to check all packing material carefully for small parts, which may have come loose inside the carton during shipment.

Step 1: Lay the Desk top (B) upside down on a carpeted or scratch-free work surface.

Step 2: Attach Wood Dowel (H) to pre-drilled holes on the End Frame (A). Carefully place the End Frame onto the Desk Top (B) by aligning the pre-drilled holes on the Desk Top (B) with the Wood Dowel of End Frame (A).

Step 3: Secure End Frame (A) to Desk Top (B) using L-Shaped Angles (C). Place the L-Shaped Angles (C) over the pre-drilled holes located in the rear of the End Frame (A) and Desk Top (B). Secure by using the 17mm long Allen Head Bolts (D), Spring Washers (E) and Flat Washers (F). Tighten with the Allen Key (G), as seen in the illustration below.

**Note:** To prevent undue stress on the Desk and Connectors, use caution while moving after assembling.

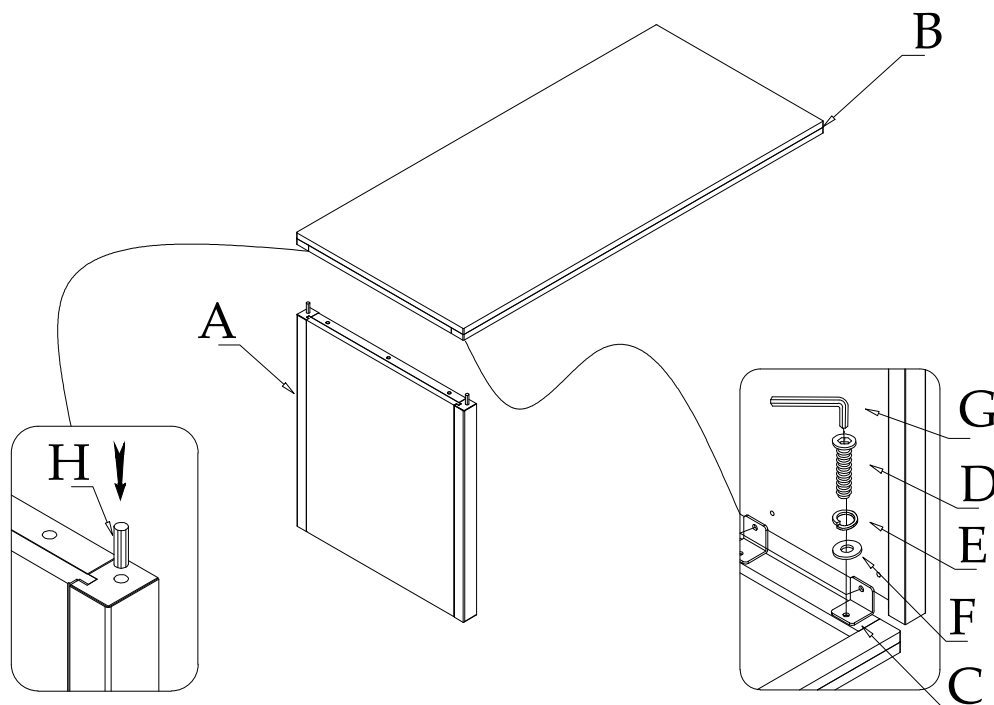

Note: The Return Desk may be attached to either end of the Bookcase.

Step 1: Attach the Connector Plate ( I ) underneath the Bookcase Top where the Return will be used, using the 17mm long Allen Head Bolts (D), Spring Washers (E) and Flat Washers (F). Tighten with the Allen Key (G), as seen in the illustration below.

Step 2: Place the end of the Return Desk top on top of the Connector Plate, close to the Bookcase, making sure the two units are properly aligned.

Step 3: Secure Desk to Bookcase using the Connector plate and the same Bolts and Washers as previous Step. Tighten with the Allen Wrench.

There are levelers underneath the Desk and Bookcase which can be adjusted to compensate for uneven flooring. If the furniture wobbles, determine which corner does not touch the floor correctly. With two people follow these steps:

1. Carefully elevate the item slightly to provide access to the levelers attached to the bottom.
2. Turn the levelers until adequate contact will be made with the floor. Gently set down the piece and check stability.

Repeat steps until furniture sits firmly on the floor.

