

Components and Hardware List

Ø1/4 x 1-1/2
Allen-Head Bolt

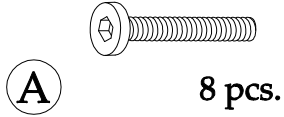

1/4" Spring
Washer

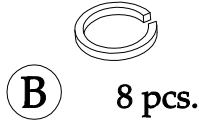

1/4" x 19mm x
2mm Flat Washer

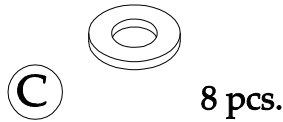

4mm Allen
Wrench

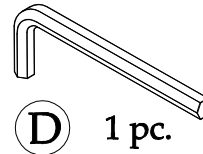

21861
Mirror

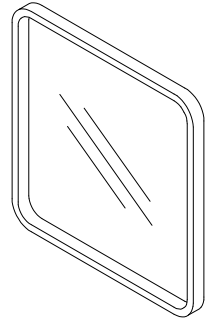

Be sure to check all packing material carefully for small parts, which may have come loose inside the carton during shipment.

There are two different methods provided for using this Mirror.

Method One is using the Hanging Wire premounted to the back of the Mirror Frame and hanging on the wall.

Method Two is to mount the Mirror to the back of the Dresser using the Mirror Supports mounted with the Bolts and Washers provided.

Note: If using the Wire Hanger to mount the Mirror, to have a safe product, the mirror must be hung on the wall using the appropriate customer supplied hardware, being properly installed, capable of supporting the weight of the mirror and suitable for the wall material.

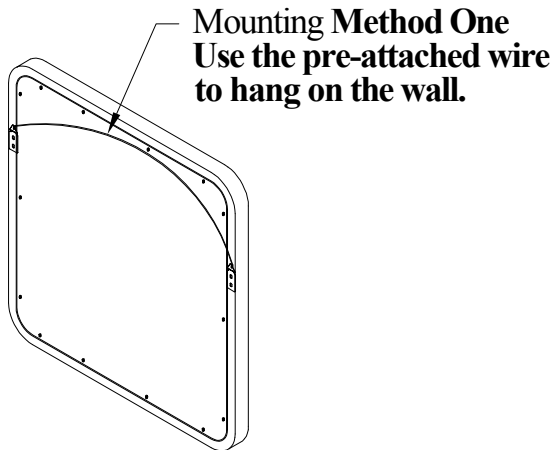
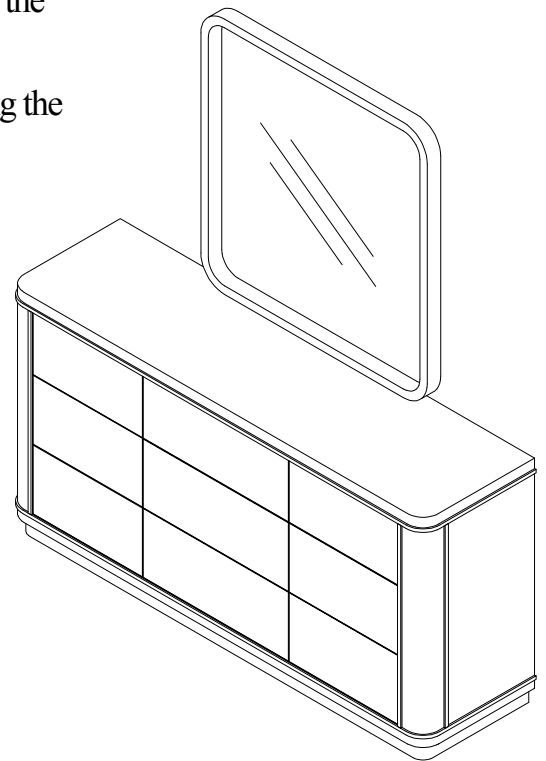

Mounting Method One
Use the pre-attached wire
to hang on the wall.

For safety and to prevent possible damage, use 2 people to attach the mirror to the dresser.

Mounting Method Two

Mirror Support, packed with Dresser

