

# #21357-1

**Riverside**  
FURNITURE

email: [info@riverside-furniture.com](mailto:info@riverside-furniture.com)

**Aberdeen**  
**Dining Room**  
**Assembly Instructions**

Page 1 of 2

Made in Viet Nam

**Components and Hardware List (for one chair)**

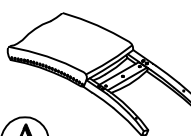
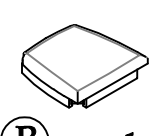
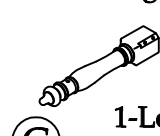
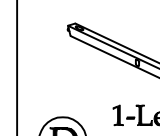
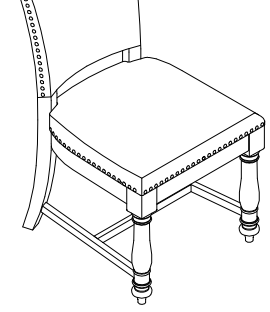
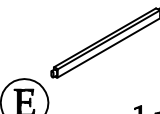
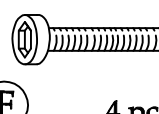
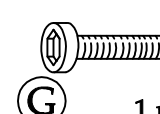
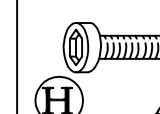
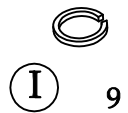
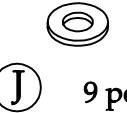
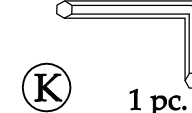
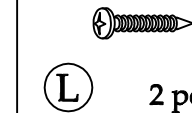
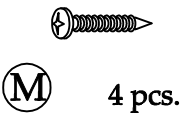
<p><b>Chair Back</b></p>  <p><b>A</b> 1 pc.</p>	<p><b>Chair Seat</b></p>  <p><b>B</b> 1 pc.</p>	<p><b>Front Leg</b></p>  <p><b>C</b> 1-Left 1-Right</p>	<p><b>Side Stretchers</b></p>  <p><b>D</b> 1-Left 1-Right</p>	 <p><b>#21357</b> <b>Uph Side Chair</b></p>	
<p><b>Middle Stretchers</b></p>  <p><b>E</b> 1 pc.</p>	<p>M5/16"-18 x 3" Allen Head Bolt</p>  <p><b>F</b> 4 pcs.</p>	<p>M5/16" -18x 1-3/4" Allen Head Bolt</p>  <p><b>G</b> 1 pc.</p>	<p>M5/16" -18x 2-1/4" Allen Head Bolt</p>  <p><b>H</b> 4 pcs.</p>		
<p>5/16" Spring Washer</p>  <p><b>I</b> 9 pcs.</p>	<p>5/16" x 19 x 2mm Flat Washer</p>  <p><b>J</b> 9 pcs.</p>	<p>5mm Allen Wrench</p>  <p><b>K</b> 1 pc.</p>	<p>#8 x 1" Wood Screw</p>  <p><b>L</b> 2 pcs.</p>		<p>#8 x 1-1/4" Wood Screw</p>  <p><b>M</b> 4 pcs.</p>

Be sure to check all packing material carefully for small parts, which may have come loose inside the carton during shipment. Separate and check all parts against the Components Hardware List above.

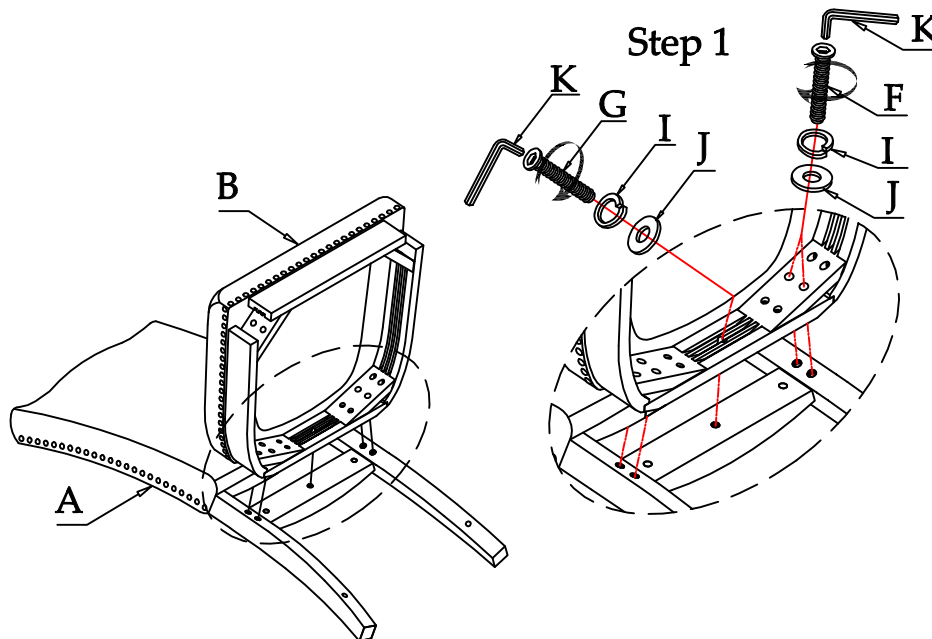

**Step 1:** Place the chair back on a padded surface, and assemble the chair seat to the chair back (as shown Step 1), using the 1-3/4" long bolt (G), in the middle of the back, and the washers as shown. Install the 3" long bolts (F), using the same washers, into the back corners of the chair seat. Do not fully tighten any bolts until after the chair has been completely assembled.

# #21357-2

*Riverside*  
FURNITURE

email: [info@riverside-furniture.com](mailto:info@riverside-furniture.com)

**Aberdeen**  
**Dining Room**  
**Assembly Instructions**

Page 2 of 2

Made in Viet Nam

## Step 2

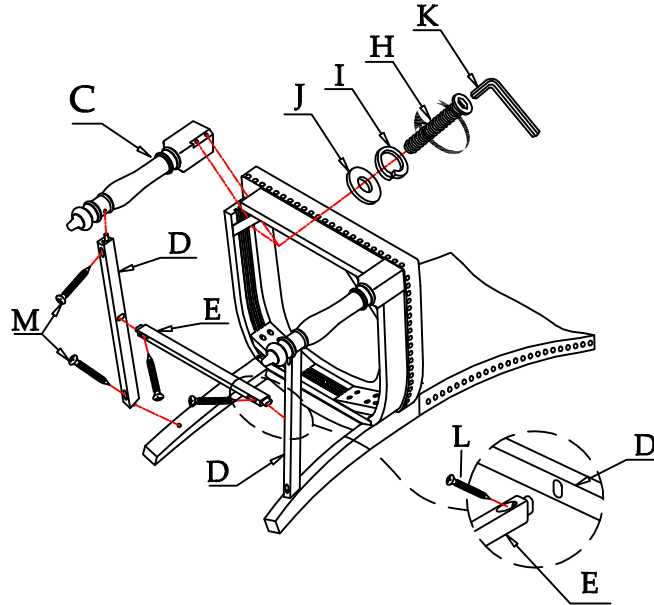

**Step 2:** Assemble the left and right side stretchers (D) to the chair back (do not install wood screws until after the next step).

**Step 3:** Assemble the middle stretcher (E) between the two side stretchers and assemble the front legs (C) onto the side stretchers and chair seat. Pull the front legs and all stretchers snugly together to verify the parts are assembled correctly. Attach the front legs using the **2-1/4"** long bolts (H), and the same washers as before. Set the assembled chair upright on a flat surface to level the chair. Tighten all bolts using the allen wrench supplied.

**Step 4:** Pull the front legs, all stretchers and chair back snugly together and using your phillips screwdriver, install the wood screws (L & M) underneath each end of the stretchers as shown.

