

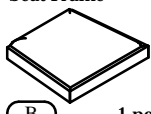





**Components and Hardware List**

<p>Chair Back</p>  <p><b>A</b> 1 pc.</p>	<p>Seat Frame</p>  <p><b>B</b> 1 pc.</p>	<p>Front Leg (Left)</p>  <p><b>C</b> 1 pc.</p>	<p>Front Leg (Right)</p>  <p><b>D</b> 1 pc.</p>	<p>Stretcher (Left)</p>  <p><b>E</b> 1 pc.</p>	<p>Stretcher (Right)</p>  <p><b>F</b> 1 pc.</p>
<p>Ø5/16" x 1-3/4" Allen Head Bolt</p>  <p><b>H1</b> 5 pcs.</p>	<p>Ø5/16" x 3-1/4" Allen Head Bolt</p>  <p><b>H2</b> 4 pcs.</p>	<p>Ø5/16" Spring Washer</p>  <p><b>H3</b> 9 pcs.</p>	<p>Ø5/16" x Ø19mm Flat Washer</p>  <p><b>H4</b> 9 pcs.</p>	<p>5 mm Allen Wrench</p>  <p><b>H5</b> 1 pc.</p>	<p>Ø9 x 1-3/4" Screw</p>  <p><b>H6</b> 4 pcs.</p>

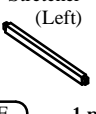
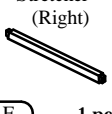
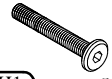
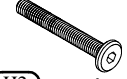

**18658&18638 Side Chair**

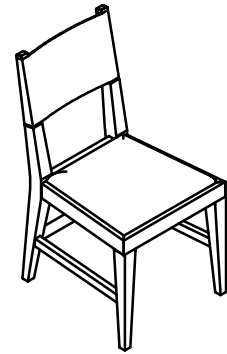
Do not fully tighten the bolts until the complete chair has been assembled.  
Once the complete chair is assembled, set it upright on a flat surface to level the chair.  
Using the provided Allen Key tighten all the bolts.

Be sure to check all packing material carefully for small parts, which may have come loose inside the carton during shipment.

To prevent possible scratches and damage, this furniture must be assembled by two people on a soft surface such as a blanket or carpet.

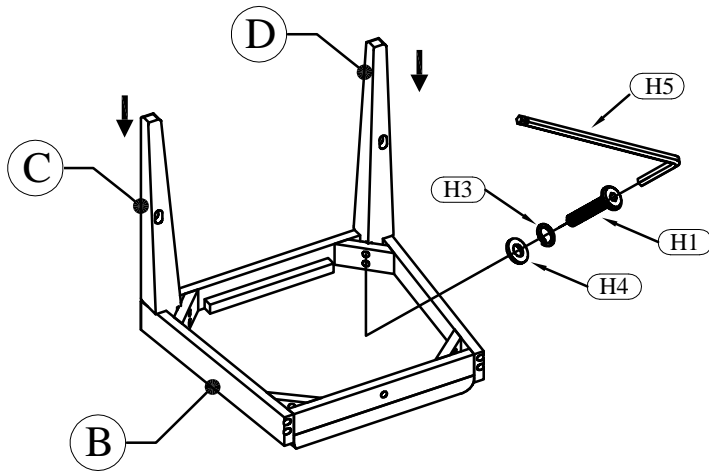

**Step: 1**

**Step: 3**

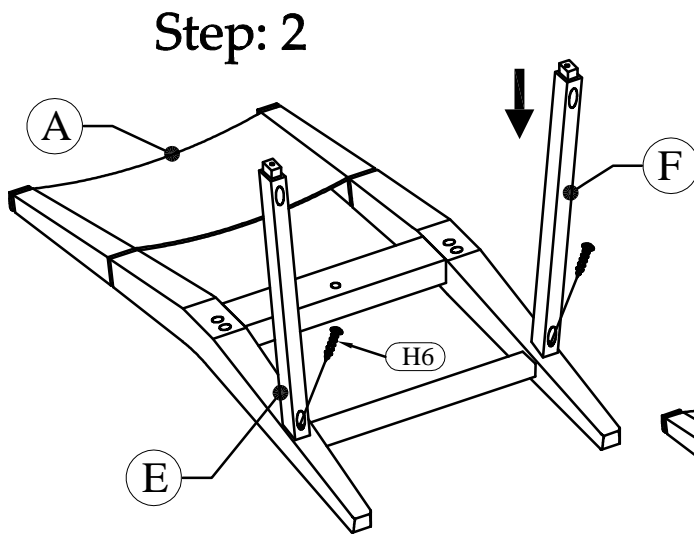

**Step: 2**

