

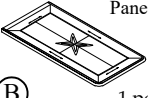

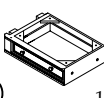







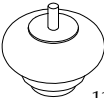
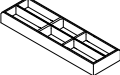

Components and Hardware List

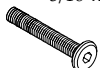
Return Desk Back Panel  1 pc.	Return Desk Top Panel  1 pc.	Knee-Hole Section  1 pc.	Pedestal  1 pc.	Bun Feet  11 pcs.
Pencil Tray  2 pcs.	Allen Head Bolt 1/4"x 1-1/4"  8 pcs.	1/4" Lock Washer  8 pcs.	1/4" Flat Washer  8 pcs.	4mm Allen Wrench  1 pc.
Allen Head Bolt 5/16"x 3"  2 pcs.	Allen Head Bolt 5/16"x 2-1/4"  2 pcs.	Allen Head Bolt 5/16"x 1-3/4"  2 pcs.	Allen Head Bolt 5/16"x 1-1/4"  4 pcs.	5/16" Lock Washer  10 pcs.
5/16" Flat Washer  10 pcs.				

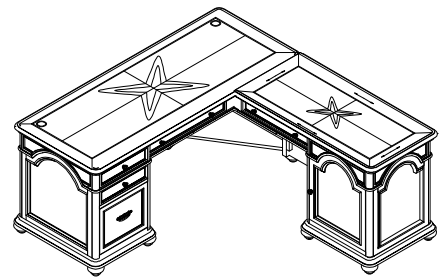

15832
L-Desk And Return

Be sure to check all packing material carefully for small parts, which may have come loose inside the carton during shipment.

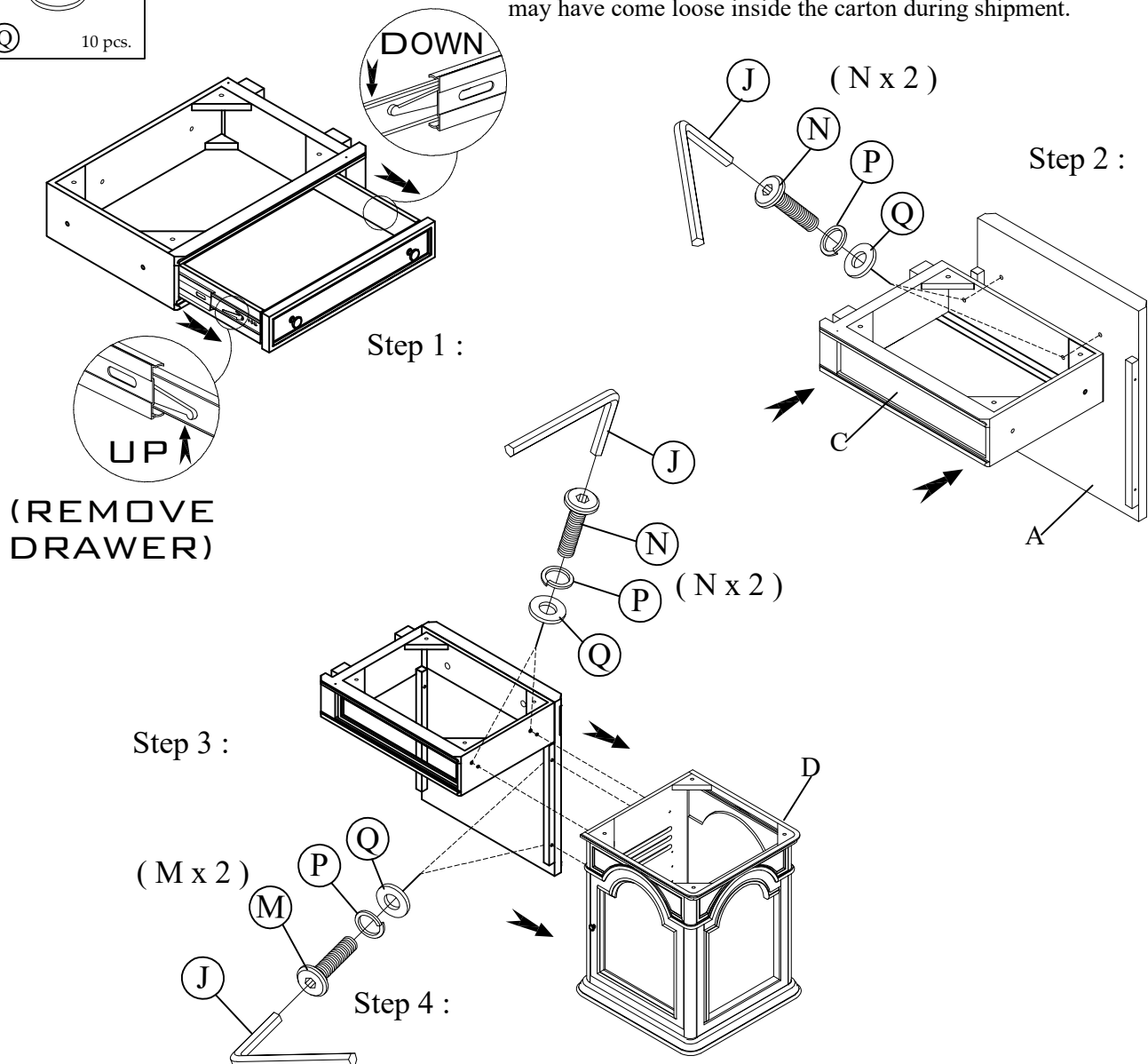

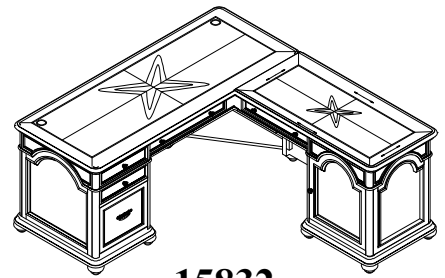
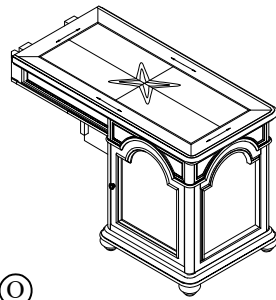
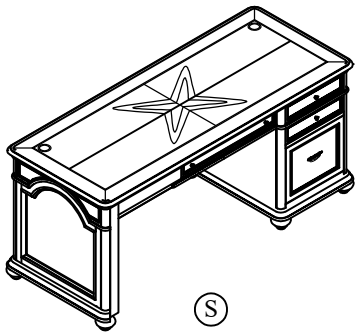

15832
L-Desk And Return

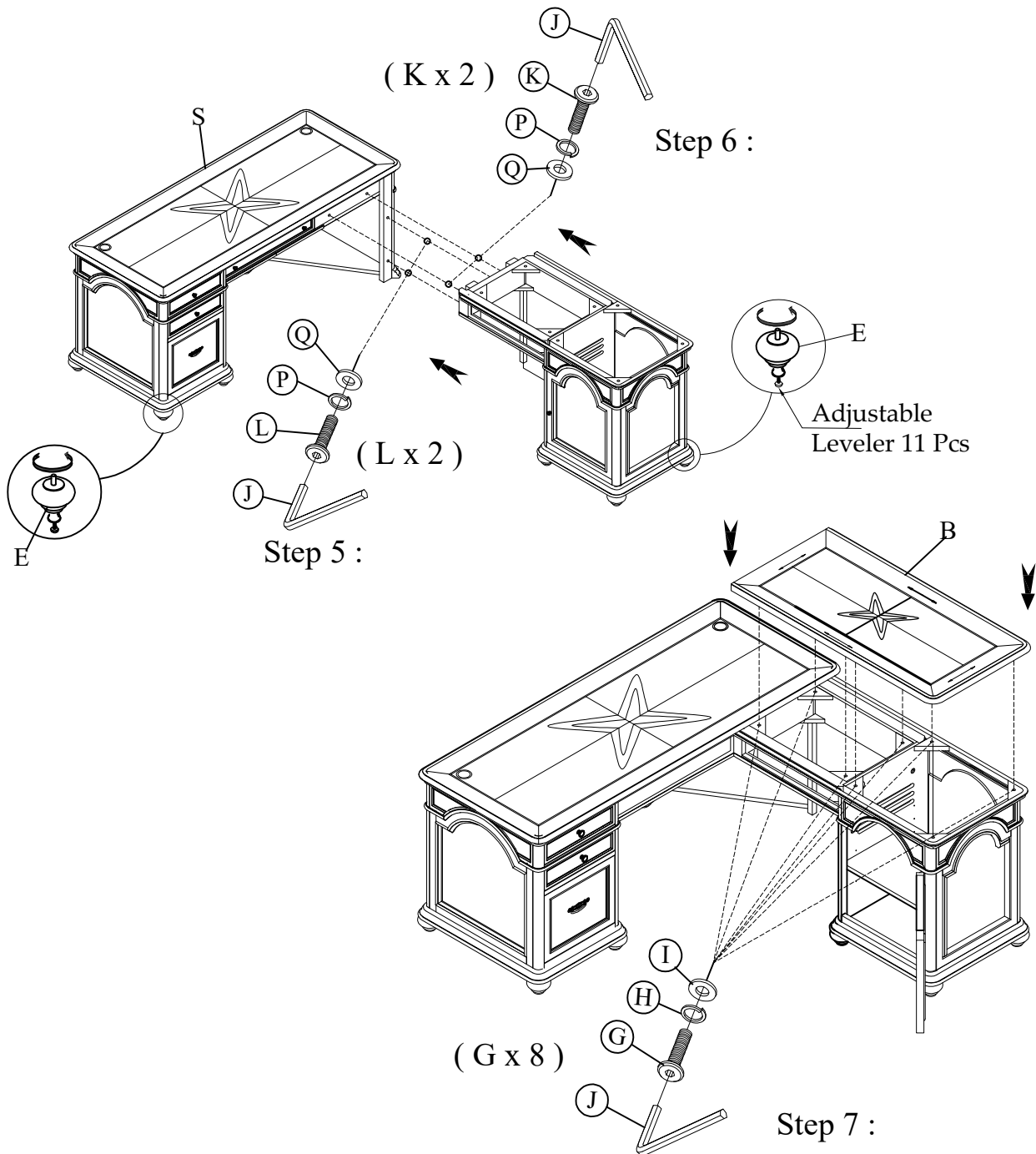

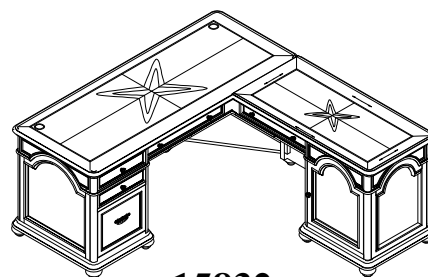

15832
L-Desk And Return

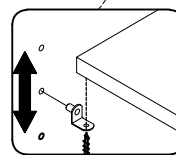
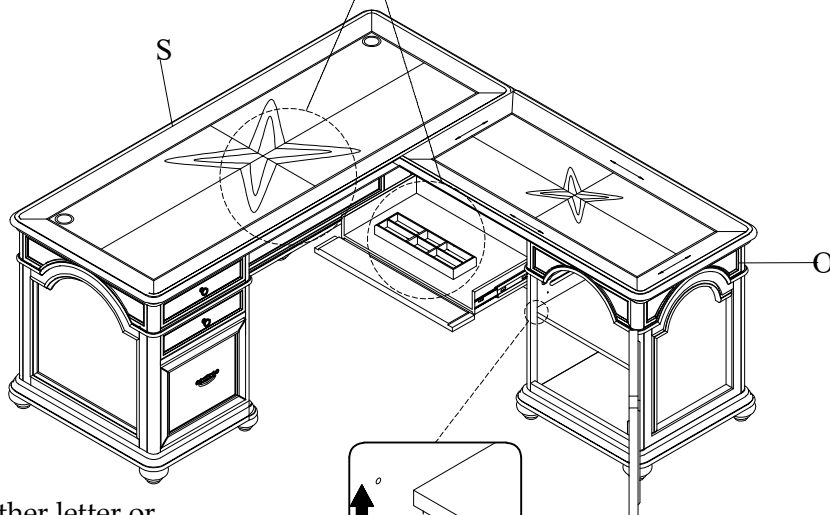
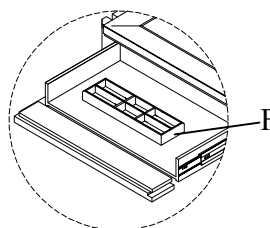
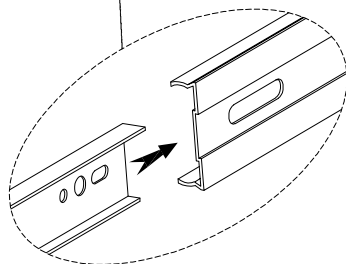
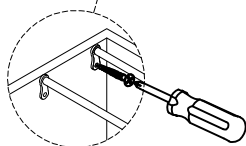
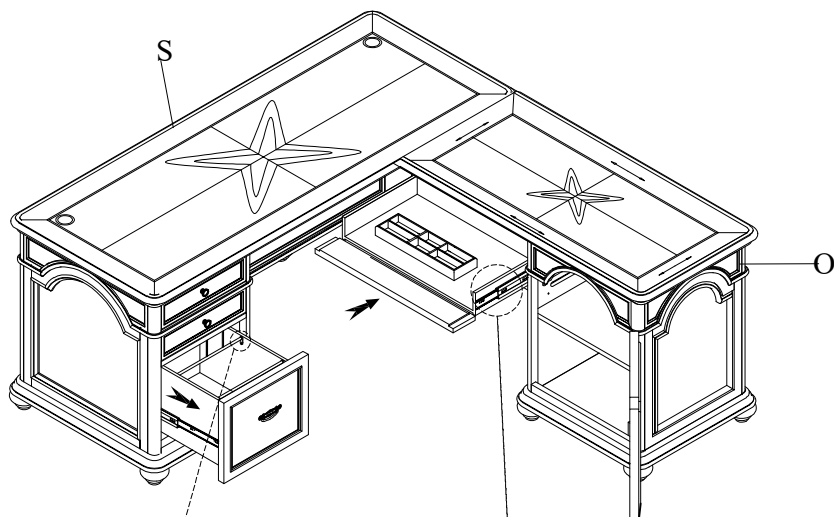
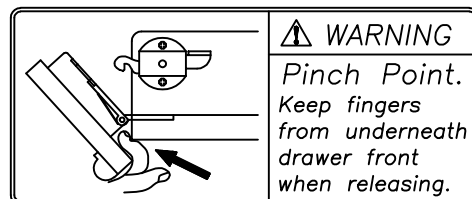

Unscrew to adjust
the shelf height

The file drawer can be set up to use either letter or legal size hanging file folders using the file rods installed in the file drawer.

The levelers in the bottom of the bun feet can be adjusted if necessary to compensate for uneven flooring.