

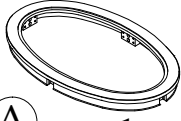





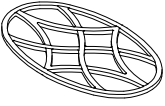
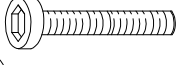
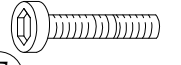

Components and Hardware List

Table Top	Top Glass	Leg	Shelf
 (A) 1 pc.	 (B) 1 pc.	 (C) 4 pcs.	 (D) 1 pc.
Ø5/16-18 x 1-5/8" Allen Head Bolt  (E) 8 pcs.	Ø5/16-18 x 5/8" Allen Head Bolt  (F) 8 pcs.	5/16" Spring Washer  (G) 16 pcs.	5/16" x 19 x 2mm Flat Washer  (H) 16 pcs.
Metal Brackets 40 x 30 x 18 x 2  (I) 4 pcs.	5mm Allen Wrench  (J) 1 pc.	Wood Cover  (K) 4 pcs.	Be sure to check all packing material carefully for small parts, which may have come loose inside the carton during shipment. To prevent possible scratches and damage, this furniture should be assembled on a soft surface such as a blanket or carpet.

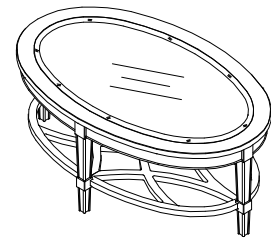

#15501
Oval
Cocktail Table

Steps
2, 3 & 4

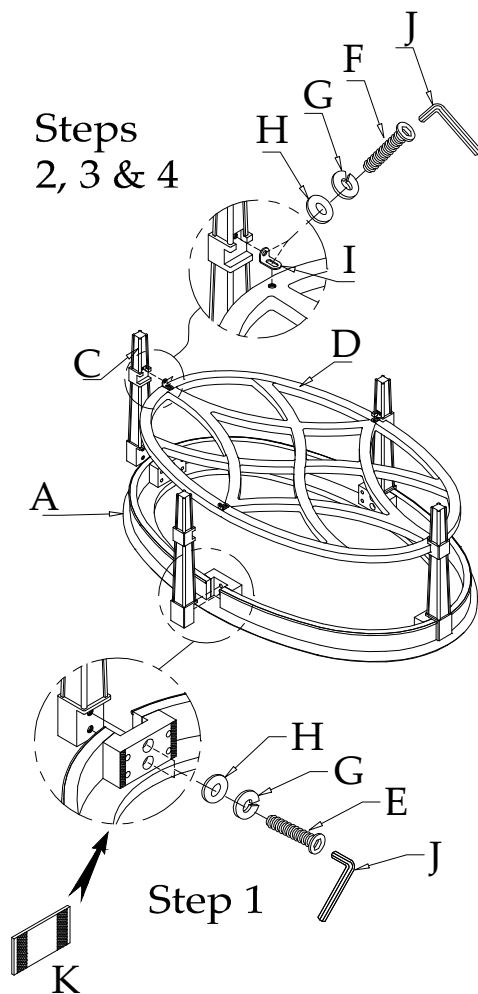

Step 5

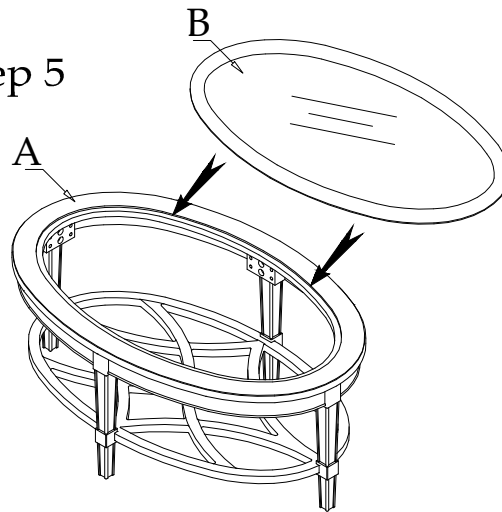

Step 1: Place the Table Top (A) upside down and assemble three (3) Legs (C) into the Top Frame using two 1-5/8" Bolts (E), Spring Washers (G), and Flat Washers (H). Only partially install Bolts until after next Step.

Step 2: Position the Shelf (D) into the notches of the Legs and attach using the Metal Brackets (I), 5/8" Long Bolts (F) and the same Washers. Do not fully tighten Bolts until Step 4.

Step 3: Attach the fourth Leg using the same Bolts and Washers as previous Steps.

Step 4: Pull each Leg snug to the Shelf and tighten the Bolts through the Metal Brackets. Tighten the Bolts attaching the top of each Leg to the Top. Apply the Wood Covers (K) onto the blocks to cover the bolt holes.

Step 5: Carefully set the assembled Table upright and install the Top Glass into the Table Top.