

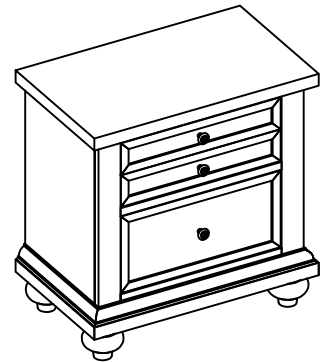



Warning :

- Be sure to check all packing material carefully for small parts, which may have come loose inside the carton during shipment.
- To prevent possible scratches and damage, this furniture must be assembled on a soft surface such as a blanket or carpet.

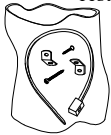

#15269
2-Drawer Nightstand

Components and Hardware List

<p>Nightstand</p>  <p>(A) 1 pc.</p>	<p>Furniture tipping restraint kit</p>  <p>(B) 1 pc.</p>	<p>Bun Foot</p>  <p>(C) 4 pcs.</p>	<p>USB Adapter</p>  <p>(D) 1 pc.</p>
---	--	--	---

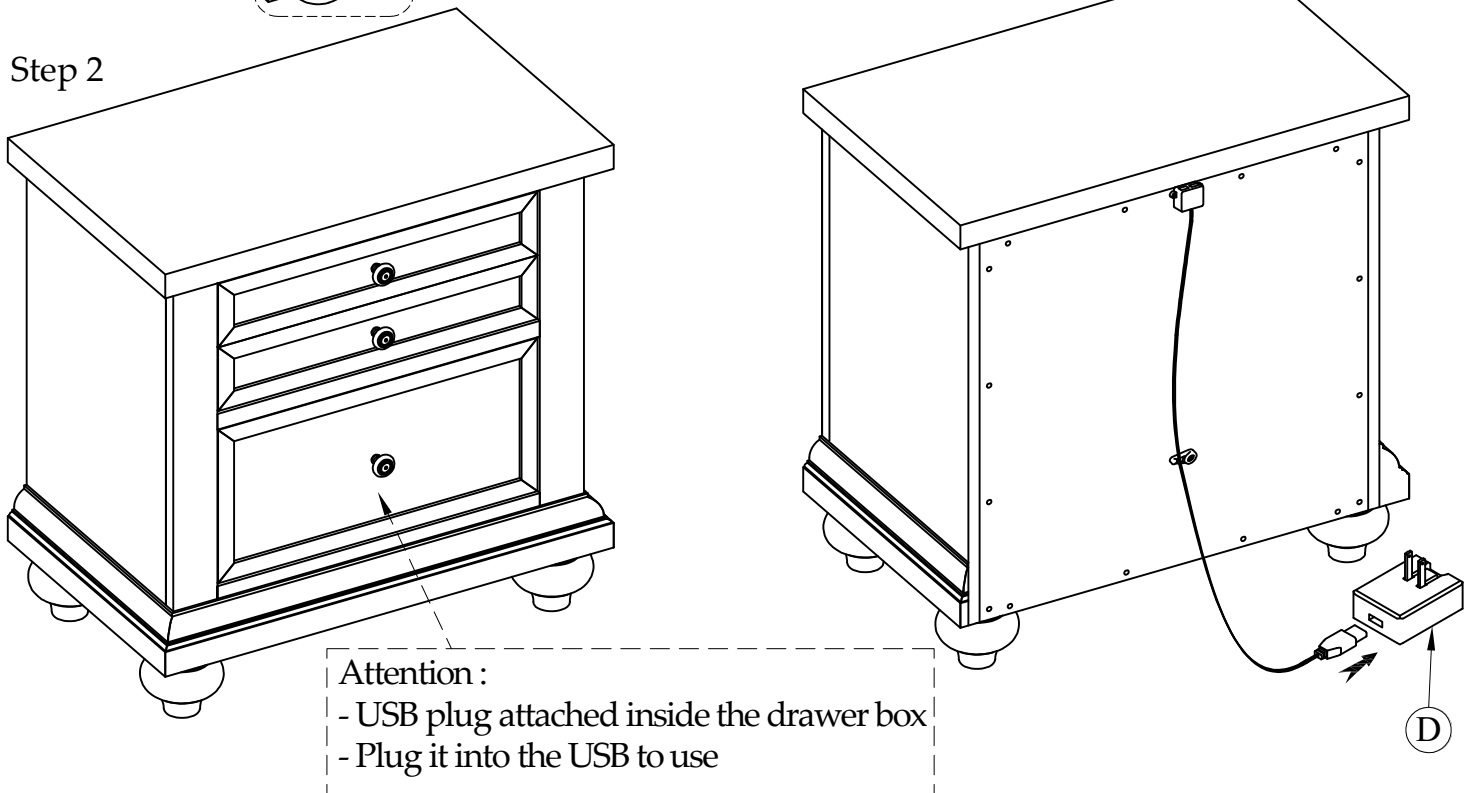
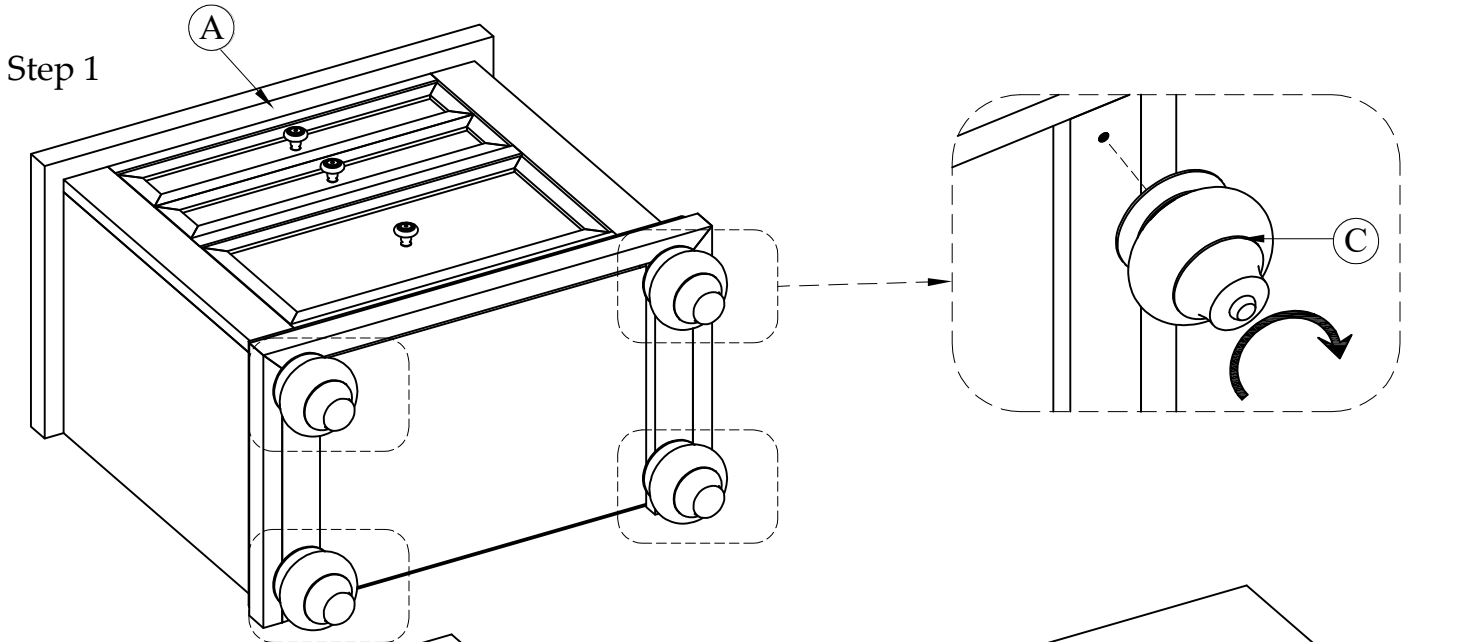

Step 3

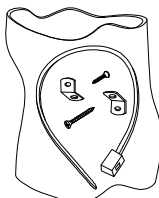

Furniture tipping restraint kit (B)
(Inside White Plastic Bag)

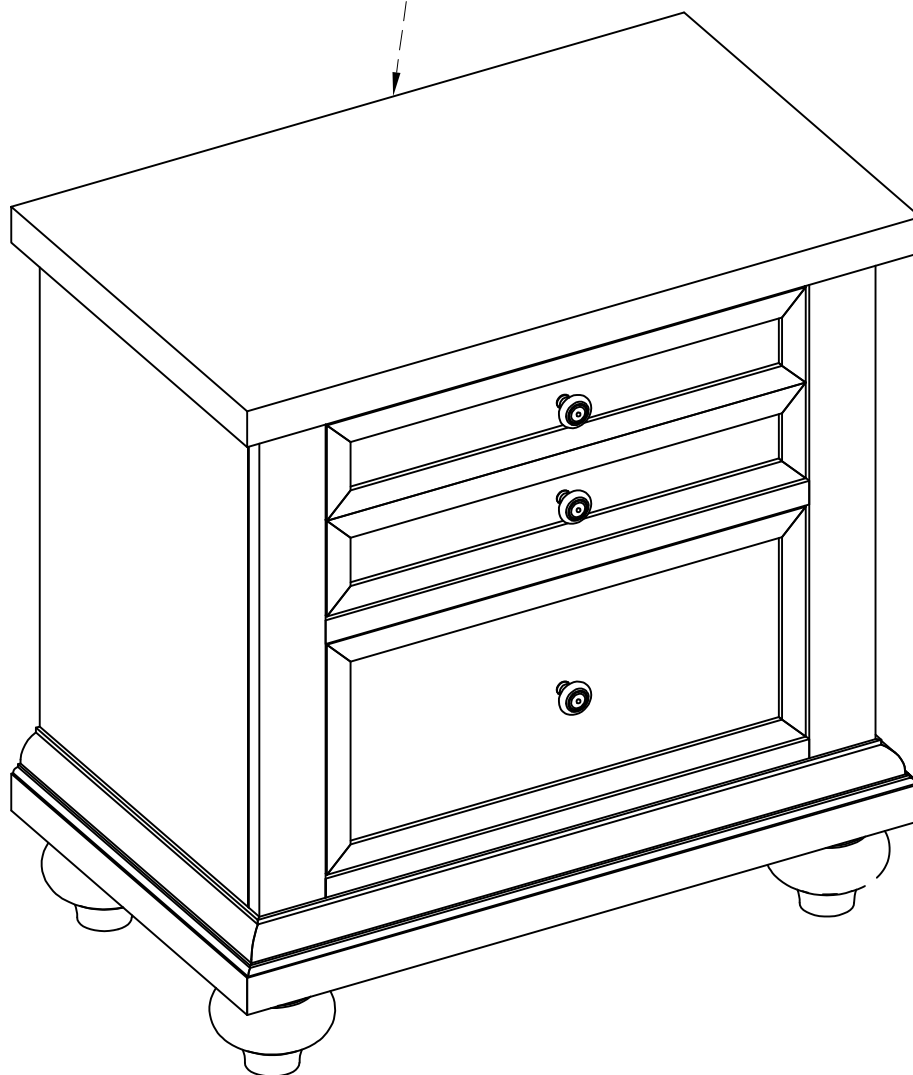

For product and personal safety, a Furniture Tipping Restraint kit has been included with this unit which can help to minimize the risk of the unit accidentally tipping forward, if used and properly installed per the manufacturer's instructions.