

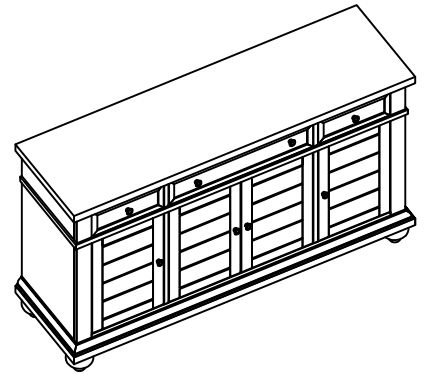

Warning :

- Be sure to check all packing material carefully for small parts, which may have come loose inside the carton during shipment.
- To prevent possible scratches and damage, this furniture **MUST BE ASSEMBLED BY TWO PEOPLE** on a soft surface such as a blanket or carpet.

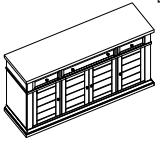

#15256
Server

Components and Hardware List

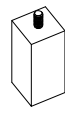
 <p>Server 1 pc.</p>	 <p>Furniture tipping restraint kit 2 pcs.</p>	 <p>Bun Foot 4 pcs.</p>	 <p>Support Leg 1 pc.</p>
---	---	--	---

Step 1

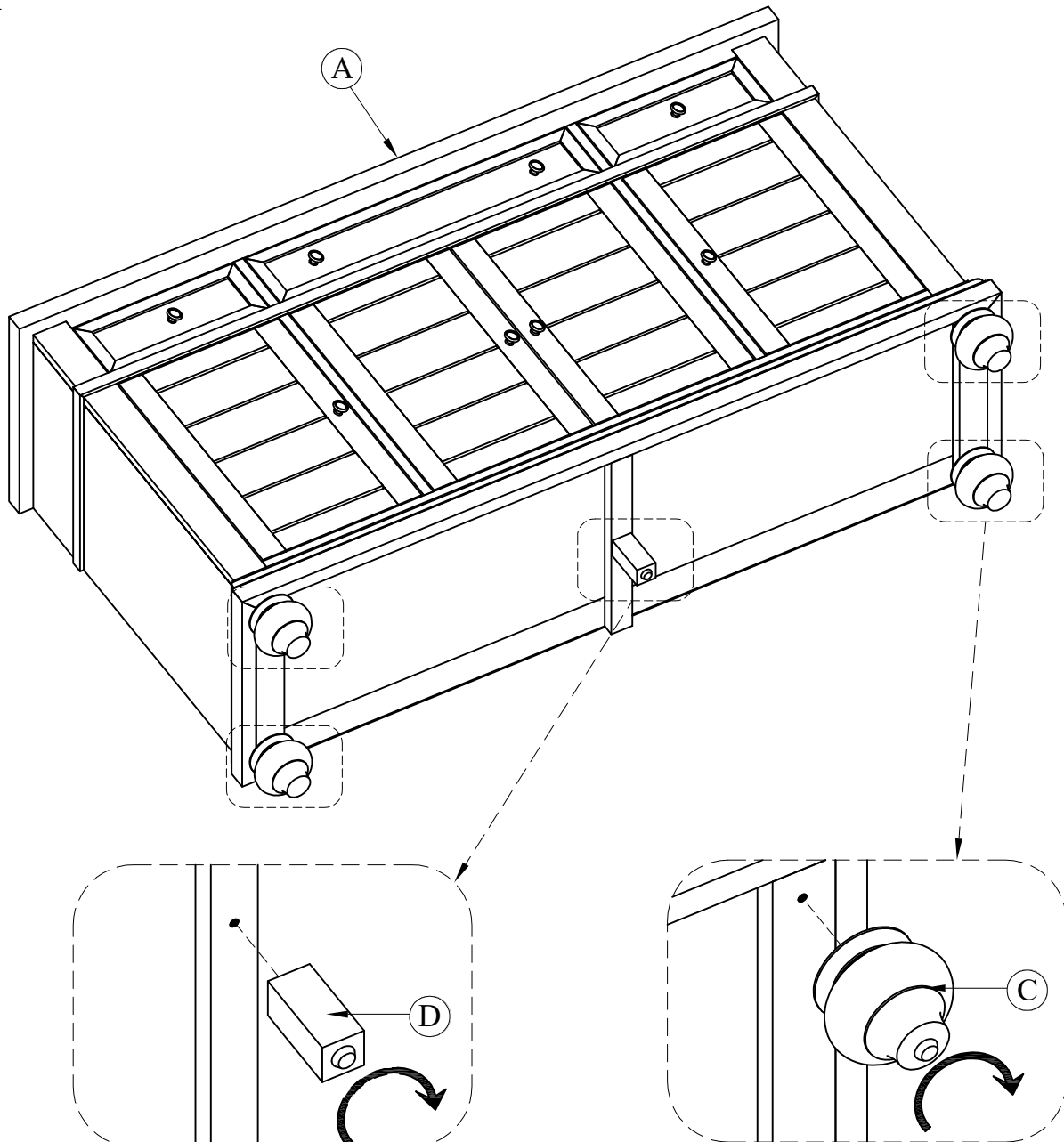

Step 2

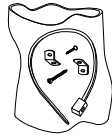

Furniture tipping restraint kit (B)
(Inside White Plastic Bag)

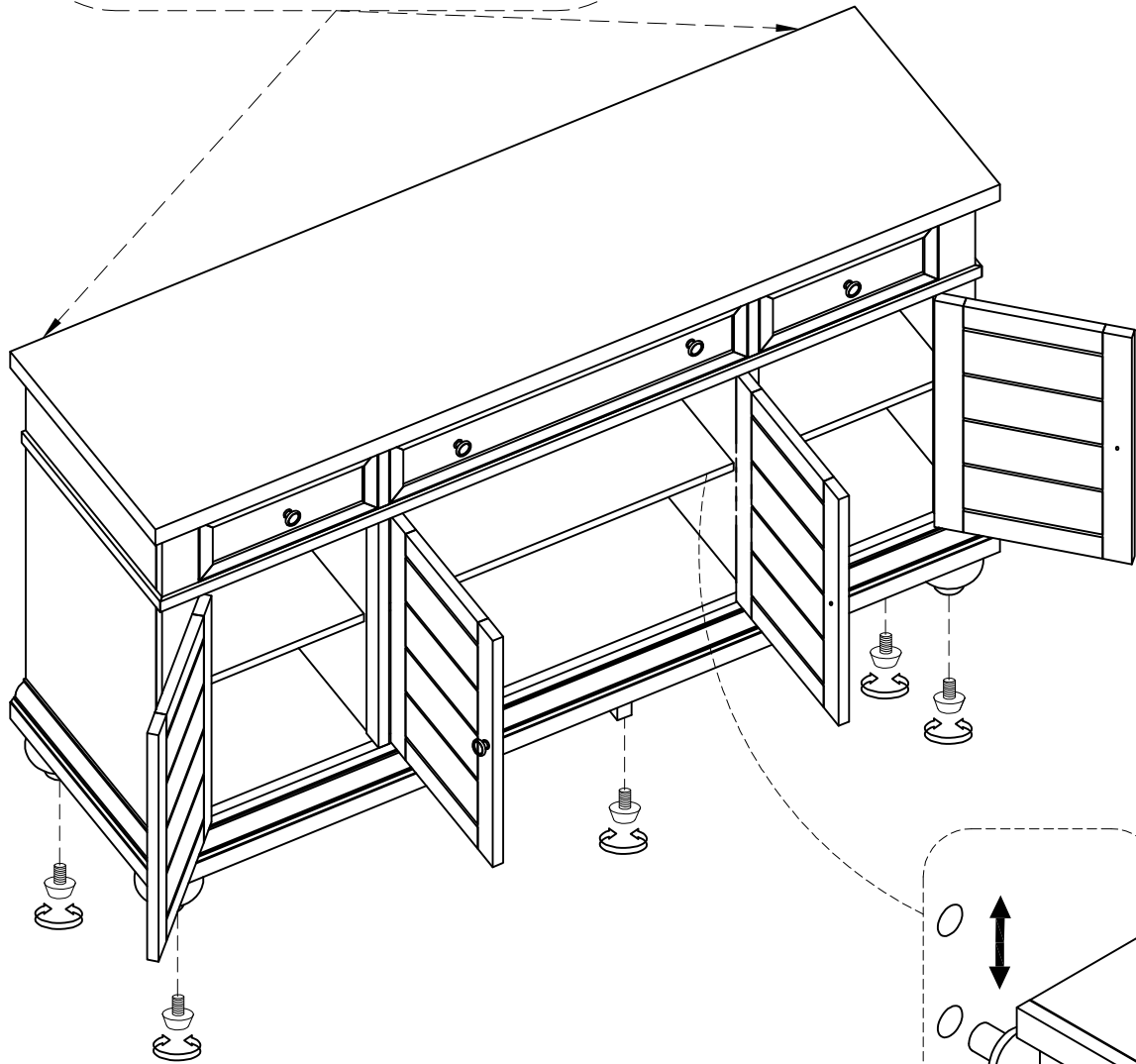

Adjustable leveler 5 pcs.

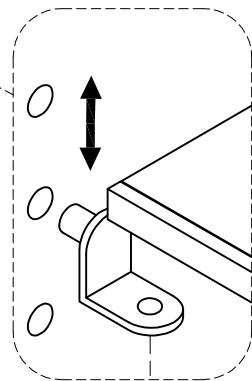

Unscrew to adjust the shelf height

For product and personal safety, 2 Furniture Tipping Restraint kit have been included with this unit which can help to minimize the risk of the unit accidentally tipping forward, if used and properly installed per the manufacturer's instructions.