

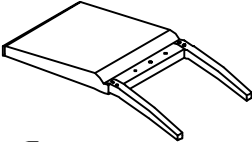

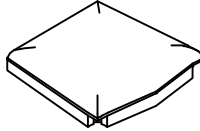

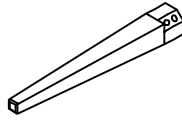

Components and Hardware List

<p>Back Chair</p>  <p>(A) 1 pc.</p>	<p>Chair Seat</p>  <p>(B) 1 pc.</p>	<p>Front Leg</p>  <p>(C) 2 pcs.</p>
---	--	--

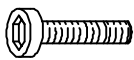
<p>M5/16" x 3-1/2" Allen Head Bolt</p>  <p>(D) 4 pcs.</p>	<p>M5/16" x 1-3/4" Allen Head Bolt</p>  <p>(E) 1 pc.</p>	<p>M5/16" x 2-1/2" Allen Head Bolt</p>  <p>(F) 4 pcs.</p>	<p>5/16"x12*3mm Spring Washer</p>  <p>(G) 9 pcs.</p>
---	--	---	--

<p>5/16" x 19*2mm Flat Washer</p>  <p>(H) 9 pcs.</p>	<p>5mm Allen Wrench</p>  <p>(I) 1 pc.</p>	<p>Slip Cover</p>  <p>(J) 1 pc.</p>
--	---	---

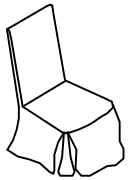
Be sure to check all packing material carefully for small parts, which may have come loose inside the carton during shipment.

To prevent possible scratches and damage, this furniture must be assembled by two people on a soft surface such as a blanket or carpet.

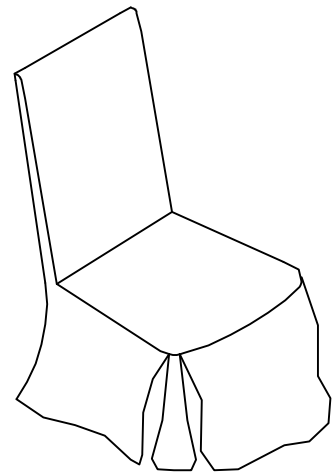

#12158
Uph Slipcover
Side Chr 2in

Step1

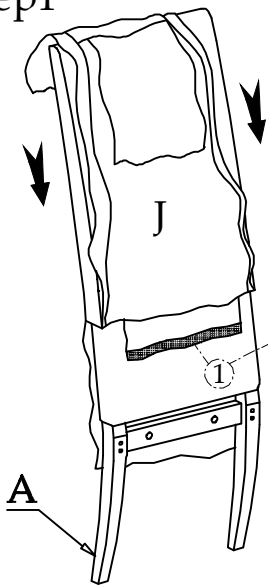

Step2

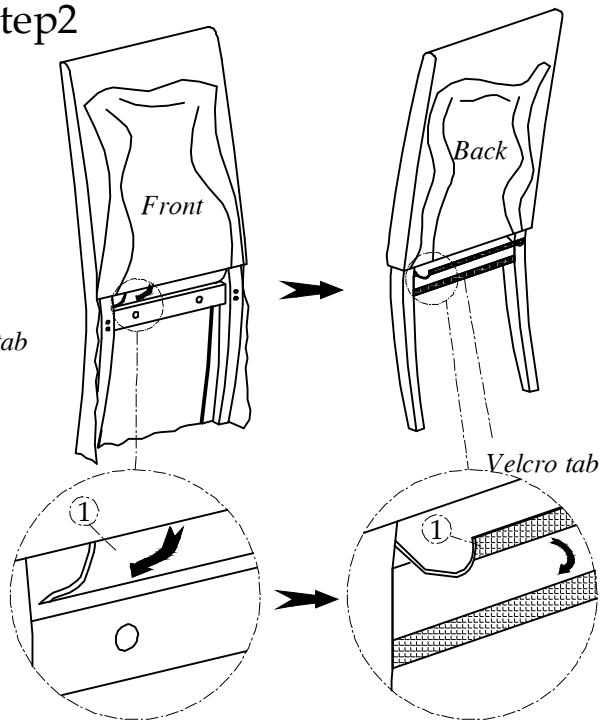

Note: Pull the Velcro tab thru the open area between wood frame and upholstered back and attach to the Velcro strip located on the back side of the wood frame rail

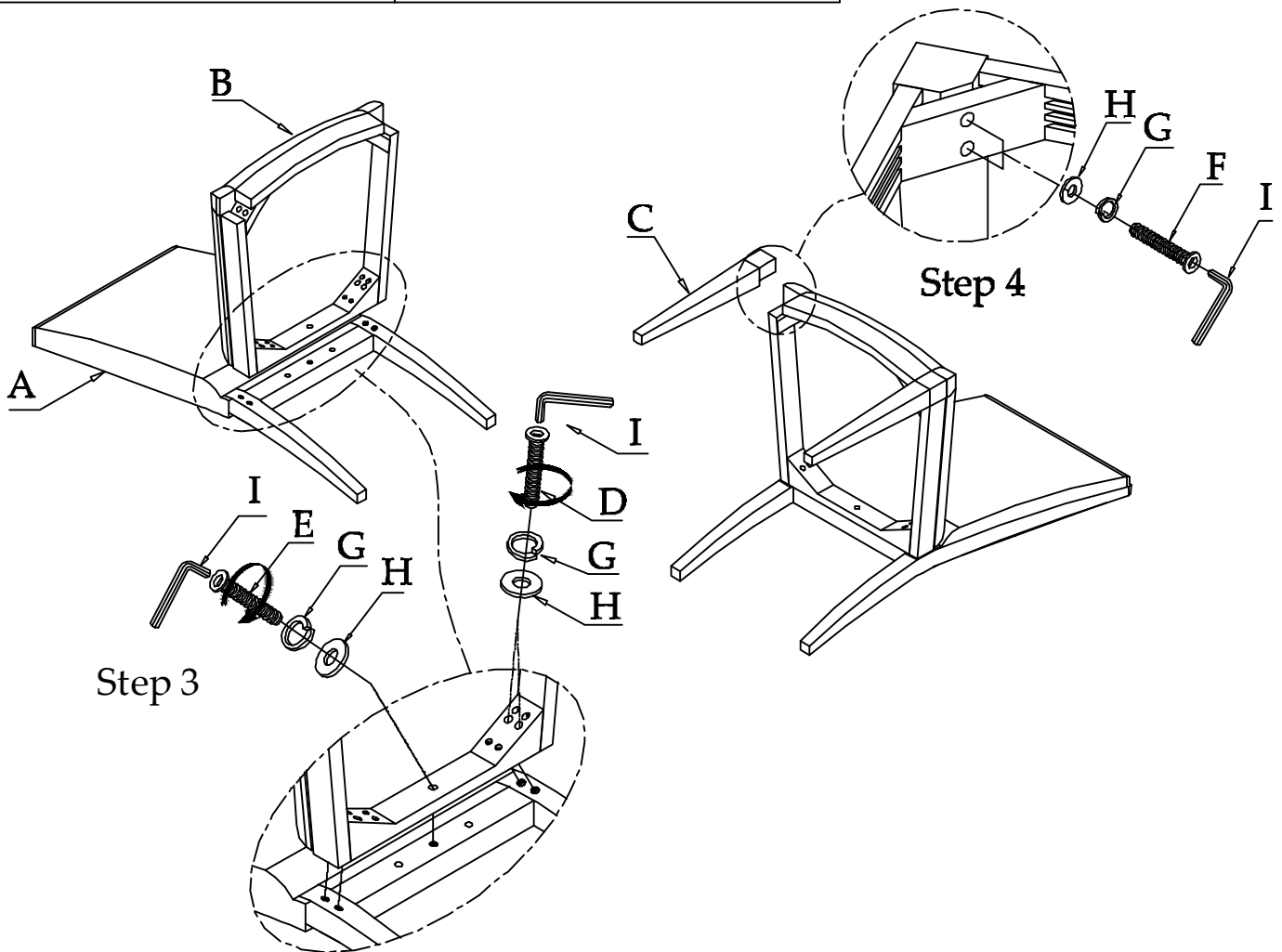

Do not fully tighten the bolts until the chair is completely assembled. Once chair is fully assembled, set the chair upright on a flat surface until it sits level and then tighten all the bolts with the Allen wrench provided. Attach all Velcro strips to the seat frame rails. Attach all Velcro strips around legs.

Step 5

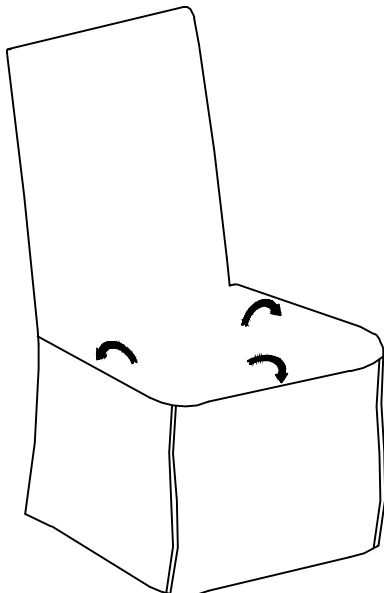

Step 6

